



**WELDING CONSUMABLES
FOR PIPELINE CONSTRUCTION**

Since BÖHLER WELDING is one of the pioneer suppliers of arc welding consumables the dedication to sophisticated applications became apparent very soon.

So when transport of oil and gas took a greater significance, BÖHLER WELDING started to engage and take interest in this business.

Pipeline construction in different climatic zones and in territories with different conditions of the soil demand from the engineers inventiveness. BÖHLER WELDING faces this very challenge alongside the prominent pipelaying companies and consequently has achieved a

world leading position in this segment with cellulosic and basic coated electrodes and wires, with weld metal toughness for safety reasons in the focus of attention.

BÖHLER WELDING consumables are world-famous both for onshore pipeline projects and for reeled offshore subsea pipeline laying from barges, because thousands of kilometres of linepipe have already been welded with them.

A comprehensive worldwide sales network of well stocked partners ensures rapid and punctual deliveries in all countries. Your nearest sales partner can be found on the Internet www.boehler-welding.com

BÖHLER WELDING consumables are available in moisture resistant and hermetically sealed packs.



Selection guide

	Steel grades API EN	Electrodes			Wire	FCAW	
		CEL	BVD	Pipe			
Low strength pipe steels							
API	A, B	FOX CEL	FOX BVD RP FOX BVD 85	FOX EV Pipe			
	X42 - X52	FOX CEL	FOX BVD RP FOX BVD 85	FOX EV Pipe FOX EV 60 Pipe	SG 3-P K-Nova Ni		
	X56 - X60	FOX CEL FOX CEL Mo FOX CEL 75 FOX CEL 85	FOX BVD RP FOX BVD 85	FOX EV Pipe FOX EV 60 Pipe	SG 3-P K-Nova Ni		
	EN	L210	FOX CEL	FOX BVD RP FOX BVD 85	FOX EV Pipe		
		L290MB-L360MB	FOX CEL	FOX BVD RP FOX BVD 85	FOX EV Pipe FOX EV 60 Pipe	SG 3-P K-Nova Ni	
		L385M-L415MB	FOX CEL FOX CEL Mo FOX CEL 75 FOX CEL 85	FOX BVD RP FOX BVD 85	FOX EV Pipe FOX EV 60 Pipe	SG 3-P K-Nova Ni	
High strength pipe steels							
API	X65	FOX CEL FOX CEL 85	FOX BVD RP FOX BVD 85	FOX EV 60 Pipe	SG 3-P K-Nova Ni		
	X70	FOX CEL FOX CEL 85 FOX CEL 90	FOX BVD RP FOX BVD 90	FOX EV 70 Pipe	K-Nova Ni NiMo 1-IG		
	X80	FOX CEL FOX CEL 90	FOX BVD RP FOX BVD 90 FOX BVD 100	FOX EV 70 Pipe	NiMo 1-IG		
	X100-X110		FOX BVD RP FOX BVD 110 FOX BVD 120				
	EN	L450MB	FOX CEL FOX CEL 85	FOX BVD RP FOX BVD 85	FOX EV 60 Pipe	SG 3-P K-Nova Ni	
L485MB		FOX CEL FOX CEL 85 FOX CEL 90	FOX BVD RP FOX BVD 90	FOX EV 70 Pipe	K-Nova Ni NiMo 1-IG		
L555MB		FOX CEL FOX CEL 90	FOX BVD RP FOX BVD 90 FOX BVD 100	FOX EV 70 Pipe	NiMo 1-IG		
Duplex steels							
	22Cr	FOX CN 22/9 N FOX CN 22/9 Nb			CN 22/9 N-IG	CN 22/9 PW-FD	

Selection depends on welding technology, see detailed recommendation for root pass, hot pass and filler layers on next pages.
 CEL = Cellulose coated electrodes
 BVD = Basic coated electrodes for vertical down welding
 Pipe = Basic coated electrodes for vertical up welding
 FCAW = Flux cored welding wire

		Page
Cellulosic electrodes for vertical down welding	Comparison table for pipe steels	5
	Recommendations for cellulose coated electrodes	7
	BÖHLER FOX CEL (AWS E6010)	8
	BÖHLER FOX CEL+ (AWS E6010)	8
	BÖHLER FOX CEL Mo (AWS E7010-A1)	8
	BÖHLER FOX CEL 75 (AWS E7010-P1)	9
	BÖHLER FOX CEL 75 G (AWS E7010-G)	29
	BÖHLER FOX CEL 85 (AWS E8010-P1)	9
	BÖHLER FOX CEL 85 G (AWS E8010-G)	29
	BÖHLER FOX CEL 90 (AWS E9010-G)	9
Welding technology	10 - 13	
Basic coated electrodes for vertical down welding	Recommendations for basic coated electrodes	15
	BÖHLER FOX BVD RP (Root pass)	16
	BÖHLER FOX BVD 85 (AWS E8018-G)	16
	BÖHLER FOX BVD 90 (AWS E9018-G)	16
	BÖHLER FOX BVD 100 (AWS E10018-G)	17
	BÖHLER FOX BVD 110 (AWS E11018-G)	17
	BÖHLER FOX BVD 120 (AWS E12018-G)	17
	Welding technology	18 - 22
Basic coated electrodes for vertical up welding	Recommendations for basic coated vertical up electrodes	24
	BÖHLER FOX EV PIPE (AWS E7016-1)	25
	BÖHLER FOX EV 60 PIPE (AWS E8016-G)	25
	BÖHLER FOX EV 70 PIPE (AWS E9016-G)	25
Consumables for automatic welding and other consumables for pipeline welding	Recommendations for automatic welding with solid wires	26
	Wires for automatic pipeline welding	27 - 28
	Other consumables for pipeline welding	29

Comparison table for pipe steels

Steel classifications			Yield strength – minimum		Tensile strength – minimum		Elongation – minimum
API 5 L-92	EN 10208-2	DIN 17172	ksi	N/mm ²	ksi	N/mm ²	%
A			30.0	207	48.0	331	28
	L210		30.4	210	46.4	320	26
		StE 210.7	30.4	210	46.4	320	26
B			35.0	241	60.0	413	23
	L245MB		35.5	245	60.2	415	22
		StE 240.7	34.8	240	53.7	370	24
X 42			42.0	289	60.0	313	23
	L290MB		42.0	290	60.2	415	21
		StE 290.7 StE 290.7 TM	42.0	290	60.9	420	23
X 46			46.0	317	63.0	434	22
	L320M		46.4	320	66.7	460	21
		StE 320.7 StE 320.7 TM	46.4	320	66.7	460	21
X 52			52.0	358	66.0	455	21
	L360MB		52.2	360	66.7	460	20
		StE 360.7 StE 360.7 TM	52.2	360	74.0	510	20
X 56			56.0	386	71.0	489	20
	L385M		55.8	385	76.9	530	19
		StE 385.7 StE 385.7 TM	55.8	385	76.9	530	19
X 60			60.0	413	75.0	517	19
	L415MB		60.2	415	75.4	520	18
		StE 415.7 StE 415.7 TM	60.2	415	79.8	550	18
X 65			65.0	448	77.0	530	18
	L450MB		65.3	450	77.6	535	18
		StE 445.7 TM	64.6	445	81.2	560	18
X 70			70.0	482	82.0	565	18
	L485MB		70.3	485	82.7	570	18
		StE 480.7 TM	69.6	480	87.0	600	18
X 80			80.0	550	90.0	620	18
	L555MB		80.5	555	90.6	625	18
		StE 550.7 TM	79.8	550	100.1	690	18



Vertical down welding using cellulosic electrodes, UAE



A project in Finland

Recommendations for cellulose coated electrodes

Steel grades API	Cellulose coated electrodes				
	FOX CEL FOX CEL S	FOX CEL Mo E 7010-A1 E 6010	FOX CEL 75 E 7010-P1	FOX CEL 85 E 8010-P1	FOX CEL 90 E 9010-G
A	■				
B	■				
X 42	■				
X 46	■				
X 52	■				
X 56	■	■	■		
X 60	■	■	■	■	
X 65	■			■	
X 70	■			■	■
X 80	■				■
Steel grades EN					
L210	■				
L245MB	■				
L290MB	■				
L320M	■				
L360MB	■				
L385M	■	■	■		
L415MB	■	■	■	■	
L450MB	■			■	■
L485MB	■			■	■
L555MB	■				■

■ for root pass welding only

■ for root pass, hot pass, filler passes and capping.

The application of FOX CEL or FOX CEL S for the root pass of the high strength steels X 60 / L415MB and upwards is very common however, their use depends upon the individual specifications and conditions. Please also note our remarks „Combination technique and welding with one electrode grade“ on pages 8 and 9.

Due to their high economy cellulose coated electrodes have been in use for decades for the welding of pipe girth welds for pipe steels up to API 5 L X 80. The high effectiveness originates from the both for root passes as well as filler and cover passes. Bigger electrode diameters in the vertical down position with high amperages and fast travel speeds.

Although BÖHLER WELDING cellulosic electrodes are designed to produce joint welds with excellent integrity and impact strength, the high hydrogen content of the weld deposit may limit the application with regard to pipe wall thickness and impact properties required.

Cellulose coated electrodes for vertical down welding

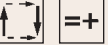
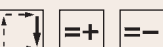
BÖHLER Standard Operating data	Welding process	Typical analysis %	Typical mechanical properties	Sizes mm	Amperage A	Approvals	Characteristics and applications	Base metals Standard Classification EN API
FOX CEL EN 499:1994 - E 38 3 C 2 1 AWS A5.1-04: E6010 AWS 5.1M-04: E4310  Polarity negative or root pass. Re-drying: not allowed For preheating, interpass temperature and welding procedure note our recommendations on pages 10 and 11.	SMAW	C 0.12 Si 0.14 Mn 0.5	Re 450 (≥ 390) N/mm ² Rm 520 (≥ 470-540) N/mm ² AS 26 (≥ 22) % Av +20°C: 110 (≥ 70) J ± 0°C: 105 J -20°C: 95 J -30°C: 65 (≥ 47) -40°C: 45 J YS 65000 (≥ 57000) PSI TS 75000 (≥ 68000-78000) PSI Elongation on 4d 26 % Impact energy +68°F: 81 (≥ 52) ft-lb +32°F: 77 ft-lb -4°F: 70 (≥ 35) ft-lb -22°F: 48 ft-lb -40°F: 34 ft-lb	2.5 3.2 4.0 5.0	50-90 80-130 120-180 160-210	TÜV-D, TÜV-A, CL, DNV, FI, ISPEL, Statoil, UDT, SEPROZ, PDO, VNIIST	Cellulose-coated electrode for vertical-down welding of large diameter pipelines; suitable for root runs, hot passes, filler and cover layers. Especially recommended for root run welding. Highly economical compared with vertical-up welding. Apart from its excellent welding and gap bridging characteristics FOX CEL offers a weld deposit with outstanding impact strength values and thus offers the benefit of still more safety in field welding of pipelines. It can be used in sour gas applications (HIC-Test acc. NACE TM-02-84). Test values for SSC-test are available too.	S235JR, S275JR, S235J2G3, S275J2G3, S355J2G3, P235GH, P265GH, P355T1, P235T2-P355T2, L210NB-L415NB, L290MB-L415MB, P235G1TH, P255G1TH. Root pass up to L555NB, L555MB API Spec. 5 L: A, B, X 42, X 46, X 52, X 56. Root pass up to X 80.
FOX CEL+ EN 499:1994 - E 38 2 C 2 1 AWS A5.1-04: E6010 AWS A5.1M-04: E4310  Re-drying: not allowed For preheating, interpass temperature and welding procedure note our recommendations on pages 10 and 11.	SMAW	C 0.17 Si 0.15 Mn 0.6	Re 450 (≥ 390) N/mm ² Rm 520 (≥ 470-540) N/mm ² AS 26 (≥ 22) % Av +20°C: 105 (≥ 70) J ±0°C: 95 J -20°C: 65 (≥ 47) J -30°C: – (≥ 27) J YS 65000 (≥ 57000) PSI TS 75000 (≥ 68000-78000) PSI Elongation on 4d 26 (≥ 22) % Impact energy +68°F: 77 (≥ 52) ft-lb +32°F: 70 ft-lb -4°F: 48 (≥ 35) ft-lb -22°F: – (≥ 20) ft-lb	2.5 3.2 4.0	50-90 80-130 120-180	–	Cellulose-coated electrode for vertical-down welding of large diameter pipelines. Especially recommended for root pass welding on D.C. positive polarity in the vertical down and vertical up welding positions. Apart from its good welding and gap bridging characteristics Böhler FOX CEL+ provides a powerful arc that deposits well penetrated, smooth root passes with high travel speeds as well as high safety against the formation of piping or hollow bead and undercut..	S235JR, S275JR, S235J2G3, S275J2G3, S355J2G3, P235GH, P265GH, P355T1, P235T2-P355T2, L210NB-L415NB, L290MB-L415MB, P235G1TH, P255G1TH. Root pass up to L555NB, L555MB API Spec. 5 L: A, B, X 42, X 46, X 52, X 56. Root pass up to X 80.
FOX CEL Mo EN 499:1994 E 42 3 Mo C 2 5 AWS A5.5-96: E7010-A1  Polarity negative for root pass. Re-drying: not allowed For preheating, interpass temperature and welding procedure note our recommendations on pages 10 and 11.	SMAW	C 0.1 Si 0.14 Mn 0.4 Mo 0.5	Re 480 (≥ 420) N/mm ² Rm 550 (≥ 510-590) N/mm ² AS 23 (≥ 22) % Av +20°C: 100 (≥ 70) J ±0°C: 95 J -20°C: 85 J -30°C: 50 (≥ 47) J -40°C: 42 J YS 70000 (≥ 61000) PSI TS 80000 (≥ 74000-85500) PSI Elongation on 4d 23 (≥ 22) % Impact energy +68°F: 74 (≥ 52) ft-lb +32°F: 70 ft-lb -4°F: 63 ft-lb -22°F: 37 (≥ 35) ft-lb -40°F: 31 ft-lb	3.2 4.0 5.0	80-130 120-180 160-210	TÜV-D, TÜV-A, ABS, CL, ISPEL, UDT, SEPROZ, VNIST	Cellulose-coated electrode for vertical-down welding of high strength large diameter pipelines. Highly economical compared with conventional vertical-up welding. Especially recommended for hot passes, filler and cover layers. Besides the excellent weld metal toughness properties it offers easy operation, and a concentrated intensive arc with deep penetration characteristics in order to ensure sound joint welds with good X-ray quality. It can be used in sour gas applications (HIC-Test acc. NACE TM-02-84). Test values for SSC-test are available too.	S235JR, S275JR, S235J2G3, S275J2G3, S355J2G3, P235GH, P265GH, L210-L415NB, L290MB-L415MB, P355T1, P235T2-P355T2, P235G1TH, P255G1TH Root pass up to L555MB. API Spec. 5 L: Grade A, B, X 42, X 46, X 52, X 56, X 60. Root pass up to X 80.

Cellulose coated electrodes for vertical down welding

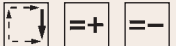
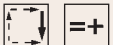
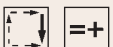
BÖHLER Standard Operating data	Welding process	Typical analysis %	Typical mechanical properties	Sizes mm	Amperage A	Approvals	Characteristics and applications	Base metals Standard Classification EN API
FOX CEL 75 EN 499:1994 - E 42 3 C 2 5 AWS A5.5-96: E7010-P1  Polarity negative for root pass. Re-drying: not allowed For preheating, interpass temperature and welding procedure note our recommendations on pages 10 and 11.	SMAW	C 0.14 Si 0.14 Mn 0.7	Re 480 (≥ 420) N/mm ² Rm 550 (510-610) N/mm ² AS 23 (≥ 22) % Av +20°C: 100 (≥ 85) J ±0°C: 95 J -20°C: 85 J -30°C: 55 (≥ 47) J -40°C: 45 (≥ 27) J YS 70000 (≥ 61000) PSI TS 80000 (≥ 74000-89000) PSI Elongation on 4d 23 (≥ 22) % Impact energy +68°F: 74 (≥ 63) ft-lb +32°F: 70 ft-lb -4°F: 63 ft-lb -22°F: 41 (≥ 35) ft-lb -40°F: 33 (≥ 20) ft-lb	3.2 4.0 5.0	80-130 120-180 160-210	TÜV-A, CL, FI, UDT	Cellulose-coated electrode for vertical-down welding of high strength large diameter pipelines. Especially recommended for hot passes, filler and cover layers. Highly economical compared with conventional verticalup welding. The penetrating arc characteristics and the low slag formation allow good bead control and ensure best performance in all positions even with the larger diameter electrodes and high amperages. It can be used in sour gas applications (HIC-Test acc. NACE TM-02-84). Test values for SSC-test are available too.	S235JR, S275JR, S235J2G3, S275J2G3, S355J2G3, P235GH, P265GH, L210-L415NB, L290MB-L415MB, P355T1, P235T2-P355T2, P235G1TH, P255G1TH. Root pass up to L480MB. API Spec. 5 L: Grade A, B, X42, X 46, X 52, X 56, X 60. Root pass up to X 70.
FOX CEL 85 EN 499:1994 E 46 4 1Ni C 2 5 AWS A5.5-96: E8010-P1  Re-drying: not allowed For preheating, interpass temperature and welding procedure note our recommendations on pages 10 and 11.	SMAW	C 0.14 Si 0.1 Mn 0.7 Ni 0.6	Re 490 (≥ 460) N/mm ² Rm 570 (550-650) N/mm ² AS 23 (≥ 20) % Av +20°C: 110 (≥ 80) J ±0°C: 105 J -20°C: 100 J -40°C: 70 (≥ 47) J YS 71000 (≥ 67000) PSI TS 82000 (≥ 80000-94000) PSI Elongation on 4d 23 (≥ 20) % Impact energy +68°F: 81 (≥ 59) ft-lb +32°F: 77 ft-lb -4°F: 74 ft-lb -40°F: 52 (≥ 35) ft-lb	3.2 4.0 5.0	80-130 120-180 160-210	TÜV-D TÜV-A ABS, CL, FI, GdF, ISPEL, UDT, SEPROZ, PDO	Cellulose-coated electrode for vertical-down welding of high strength large diameter pipelines. Highly economical compared with conventional vertical-up welding. Especially recommended for hot passes, filler and cover layers. Without doubt BÖHLER FOX CEL 85 is the most popular cellulosic electrode which meets all the exacting demands of the field welding of cross country pipelines extremely well. It ensures highest joint weld qualitydown to temperatures of -40 °C. It can be used in sour gas applications (HIC-Test acc. NACE TM-02-84). Test values for SSC-test are available too.	L415NB-L485NB, L415MB-L485MB. API Spec. 5 L: X 56, X 60, X 65, X 70
FOX CEL 90 EN 499:1994 E 50 3 1Ni C 2 5 AWS A5.5-96: E9010-G  Re-drying: not allowed For preheating, interpass temperature and welding procedure note our recommendations on pages 10 and 11.	SMAW	C 0.17 Si 0.15 Mn 0.9 Ni 0.8	Re 610 (≥ 530) N/mm ² Rm 650 (620-720) N/mm ² AS 21 (≥ 18) % Av +20°C: 100 (≥ 80) J ±0°C: 90 J -20°C: 75 J -30°C: 65 (≥ 47) J -40°C: 40 (≥ 27) J YS 89000 (≥ 77000) PSI TS 94000 (≥ 90000-104400) PSI Elongation on 4d 21 (≥ 18) % Impact energy +68°F: 74 (≥ 59) ft-lb +32°F: 66 ft-lb -4°F: 55 ft-lb -22°F: 48 (≥ 35) ft-lb -40°F: 30 (≥ 35) ft-lb	4.0 5.0	120-180 160-210	TÜV-D, TÜV-A, CL, GdF, ISPEL, Statoil, UDT, SEPROZ, VNIIST	Cellulose-coated electrode for vertical-down welding of high strength large diameter pipelines. Highly economical compared with conventional vertical-up welding. Especially recommended for hot passes, filler and cover layers. The special design of the coating and the core wire guarantees the highest metallurgical quality and soundness of the weld metal deposit with excellent mechanical properties. The electrode allows good weld pool visibility, and easy manipulation in all positions, as well as high safety margins against porosity and slag inclusions.	L450MB, L485MB, L555MB. API Spec. 5 L: X 65, X 70, X 80

Preheating and interpass temperature

In order to prevent hydrogen induced cracks it is necessary to preheat the pipes before commencing welding and to maintain an interpass temperature during welding of the individual beads.

In respect of the quite often difficult site conditions a pre-heating of 150 °C (300 °F) general is recommended. This covers all wall thicknesses up to 25 mm (1") and weld metals up to class E9010 (FOX CEL 90). When welding thin walled pipes be aware that lower preheating and interpass temperatures are applicable.

The attached diagram features the lowest possible temperatures in dependence on the wall thickness and type of electrode.

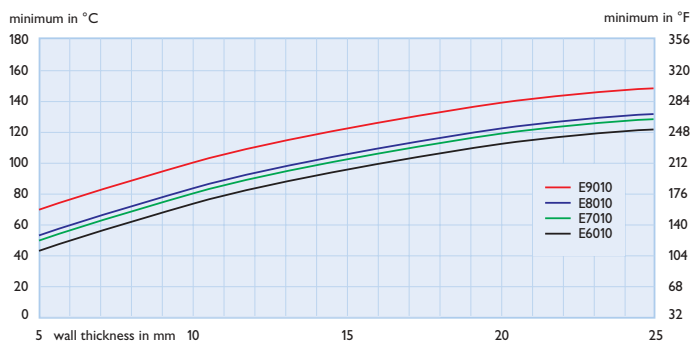

Welding machines

Cellulose coated electrodes can only be operated on direct current. Welding machines must have a drooping characteristic and high open circuit voltage.

In manual arc welding, the distance between the electrode and the weld pool or joint faces, respectively, can hardly be kept constant, i.e. the length of the arc will vary and so will the amperage. The use of welding machines with drooping characteristics minimizes these variations. **The open circuit voltage must exceed 70 V** in order to provide the high ionization energy required for dissociation of the constituents making up the coating of the electrode. Generators used for welding with cellulose pipeline electrodes usually have an open circuit voltage in the range of 80 to 100 V.

Larger electrode diameters require high amperages as well as high voltages, which the generators must deliver during welding.

These requirements must be fulfilled by welding machines in general; other details, such as type and mode of operation, may vary for different makes, and will be supplied by the manufacturer.

Recommended joint preparation

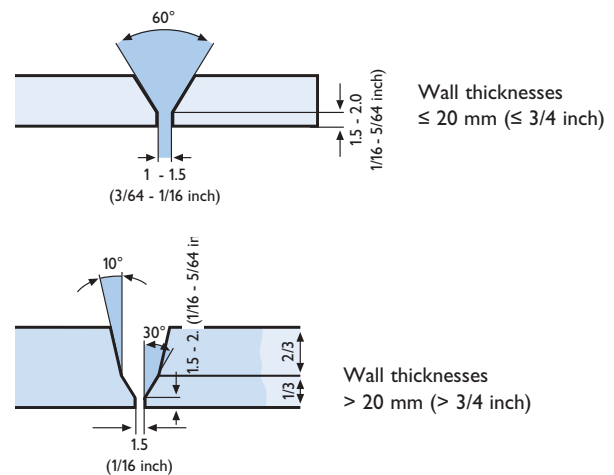

Welding technique Stringer bead or root pass

With pipes positioned and held in true alignment with line-up clamps, the stringer bead or root pass is welded. For pipe diameters over 200 mm (8"), it has become general practice to have two welders work on opposite sides of the pipe. Even three or four welders may work simultaneously in order to reduce distortion and maintain uniform gap width. Three to four welders are employed for executing the root pass in pipe of more than 700 mm (28") diameter or on difficult ground. **For this most important part of the weld which requires perfect penetration, electrode diameter, travel rate and amperage should be chosen to match pipe diameter and wall thickness.** For pipe diameters up to about 250 mm (10") and wall thicknesses up to 8 mm (5/16"), we recommend to use 3.2 mm (1/8") diameter electrodes, for larger sizes, 4 mm (5/32") diameter electrodes. Welding proceeds vertical down, with the electrode being held to maintain good contact with the bevel faces. The procedure recommended is electrode negative.

Electrode diameter:

∅ 2.5 mm (3/32")	50 - 180 A
∅ 3.2 mm (1/8")	80 - 100 A
∅ 4 mm (5/32")	120 - 150 A

Line-up clamps should be removed only after completing the root pass over the whole circumference and, in welding larger diameter pipe, only after completing the hot pass. While executing this pass, do not move pipes in order to avoid the risk of crack formation.

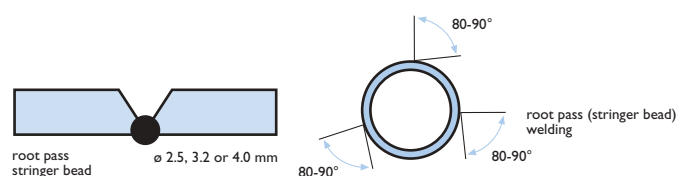

Cellulose coated electrodes

Hot pass

Slight grinding of the stringer bead surface with rotating steel wire brushes prevents lateral slag inclusions (showing up as „waggon tracks“ in weld radiographs). For welding the hot pass, the electrode is held almost vertical, high amperage being used with the electrode connected to the positive terminal.

Electrode sizes commonly used are:

4 mm	(5/32")	with 150 - 180 A
5 mm	(3/16")	with 170 - 210 A

The high current causes deep penetration which will make any remaining slag inclusions float to the surface and ensure that the root pass is annealed thoroughly. **The hot pass should be welded immediately following deposition of the stringer bead, but in no case more than 10 minutes later.** This is of special importance for high strength line pipe grades to avoid under bead cracking in the base material.

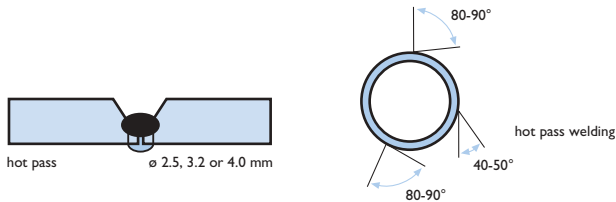

Filler passes

Beads will be sufficiently flat, and free from undercut and slag inclusions, if the electrode is applied with a slight circular or stepping motion, especially in positions 12 to 2 o'clock, 12 to 10 o'clock, 4 to 6 o'clock and 8 to 6 o'clock. Weaving is recommended for all other positions. Rotating steel wire brushes are used to remove slag carefully after each pass. Selection of electrode diameter depends on pipe diameter and wall thickness.

Electrode sizes and amperages recommended for filler pass welding on positive (+) polarity:

4 mm	(5/32")	120 - 150 A
5 mm	(3/16")	160 - 210 A
5.5 mm	(7/32")	200 - 260 A

Vertical down welding will yield bead thicknesses varying for different pipe welding positions. Therefore, prior to welding the cover pass, it is usually necessary to apply stripper passes on those parts of the pipe circumference where thickness must be corrected. Stripper passes are applied in a relatively fast movement, in positions 2 to 4 o'clock and 10 to 8 o'clock.

Cover pass or cap

The cover pass is executed with a slight weaving of the electrode. The weld should not overlap the groove edge by more than 1.5 mm (1/16"). If the cover pass is applied correctly, weld reinforcement is about 1 to 2 mm (1/16"). **For this pass, electrode diameter usually is 5 mm (3/16"), with amperage slightly lower than for filler passes (150-200 A) in order to**

avoid porosity. In the cover pass, porosity is mostly due to overheating of the weld deposit or excessive weaving.

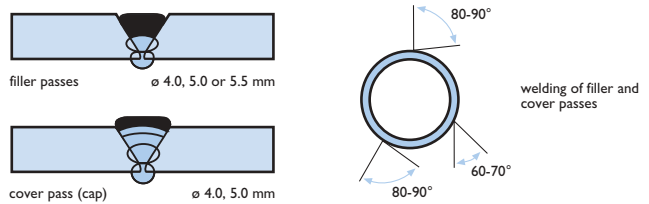











Combination technique and welding with one electrode grade

The weld deposit of the root pass which has not been tempered by application of the hot pass may have a strength which is 100 to 150 N/mm² (~18000 psi) above that of the finished joint. This, and the notch-sensitive shape of the stringer bead may, in case of uncontrolled pipe movement during the welding operation, cause mechanical crack formation before the hot pass is deposited. The combination weld technique which has been recommended and practised successfully for years is an excellent method of avoiding this risk. **The combination technique involves welding the stringer bead in higher carbon, higher strength steels with an electrode of lower strength compared to that of the base metal, but giving better ductility (FOX CEL).** A comparatively soft and tough stringer bead will absorb mechanical stresses better while it is being welded and before the hot pass is applied. **The combination technique has proved highly satisfactory for higher carbon steels, in particular.** In spite of its lower strength level, the electrode used for stringer bead welding is compensated in strength due to about 50 % dilution with the base metal. In welding low carbon, reduced pearlite steels, however, the high dilution of the root pass will reduce the strength in this part of the joint. In thin wall pipe, the stringer bead cross section constitutes a larger percentage of the overall pipe cross section than in heavy wall pipe. This may account for additional reduction in strength over the whole cross section. **Therefore, we recommend using one electrode grade for all passes, from stringer bead to cap, in line pipe from reduced pearlite steels with less than 0.10 % carbon, having wall thickness below 10 mm (13/32").** Mechanical properties of this electrode grade should equal those of the base metal.

Storage

The coating of cellulose electrodes has a relatively high content of moisture which is necessary for the welding characteristics and metallurgical properties of the deposit. In open, unprotected storage, air humidity and/or temperature may reduce or increase the moisture content considerably. Therefore, BÖHLER cellulose electrodes are packed in cans. **Electrodes should be kept in closed storage where prolonged exposure to solar radiation and excessive variations in temperature can be avoided. Once a can has been opened, the electrodes should be used up as soon as possible. Rebaking of cellulose electrodes is not permitted.**

Trouble shooting	Defects	Causes	How to avoid defects
	Porosity visible on the surface	<ul style="list-style-type: none"> excessive and uncontrolled weaving base metal overheated (increased risk in thin wall pipe) moisture content of electrode coating too low 	<ul style="list-style-type: none"> weaving not to exceed 2 X electrode dia. choose electrode dia. and amperage as a function of pipe wall thickness keep electrodes in closed containers see Chapter on page 13 „storage“
	Pinholes not visible on the surface	<ul style="list-style-type: none"> delayed deoxidation process in weld deposit moisture content in electrode coating too low or too high 	<ul style="list-style-type: none"> avoid excessive upsetting of metal deposited see Chapter on page 13 „storage“
	Piping or hollow bead almost exclusively in the reinforcement of stringer bead - therefore, practically no reduction of cross section	<ul style="list-style-type: none"> root gap too narrow: degassing hindered by excessive dilution chemical composition of base metal: high Al levels usually favour piping formation 	<ul style="list-style-type: none"> root gap width not less than 1 mm the optimum root gap width of 1.5 mm should be observed for 0.040 % Al steels in particular. If trouble continues, use smaller electrode dia.
	Slag inclusions generally occurring in groove faces and in stringer bead area (waggon tracks)	<ul style="list-style-type: none"> insufficient cleaning in between passes stringer bead poorly ground incorrect electrode manipulation amperage too low 	<ul style="list-style-type: none"> clean each layer with rotary wire brush grind stringer bead sufficiently before applying hot pass improve electrode manipulation increase amperage
	Lack of fusion (cold shuts)	<ul style="list-style-type: none"> insufficient melting of groove faces amperage too low groove faces contaminated and/or oxidized 	<ul style="list-style-type: none"> choose amperage to match electrode dia. and welding position clean groove faces properly
	Underbead cracks almost exclusively in the hardened HAZ	<ul style="list-style-type: none"> combined action of hydrogen, stresses, hardened structure 	<ul style="list-style-type: none"> preheat pipe material to favour hydrogen effusion, increase of heat input is also advantageous avoid moving pipe string considerable hardening is to be expected during welding of the stringer bead, therefore the hot pass must be applied immediately after its completion
	Cracks caused by mechanical stresses usually in the stringer bead region	<ul style="list-style-type: none"> moving of pipe string during welding of stringer bead and/or before applying hot pass edge offset too great, resulting in reduced root cross section and increased risk of crack formation 	<ul style="list-style-type: none"> avoid moving pipe particularly during welding of stringer bead refer to relevant standards and specifications for maximum offset which, however, should be kept to a minimum
	Undercut in the region of stringer bead and cover passes	<ul style="list-style-type: none"> amperage too high incorrect manipulation 	<ul style="list-style-type: none"> selection of correct amperage to match electrode size
	Excess reinforcement	<ul style="list-style-type: none"> Incorrect manipulation 	<ul style="list-style-type: none"> select amperage to match joint width allowance for desired cover pass weld reinforcement is to be made already when applying last filler pass (e.g. by additional layers or grinding of filler layers that are too high)
	Sagging stringer bead	<ul style="list-style-type: none"> amperage too high poor joint preparation, root gap too large 	<ul style="list-style-type: none"> select correct amperage to match joint preparation for stringer bead
	Striking marks	<ul style="list-style-type: none"> striking right or left of the joint causes local hardening – risk of hardening cracks 	<ul style="list-style-type: none"> strike arc in the groove

Cellulose coated electrodes

Consumption rate		Wall thickness											
Diameter	Root pass Hot pass Filler + Cap	0,25 inch 6,35 mm	0,312 inch 7,92 mm	0,432 inch 10,97 mm	0,5 inch 12,7 mm	0,562 inch 14,27 mm	0,625 inch 15,88 mm	0,719 inch 18,26 mm	0,812 inch 20,62 mm	0,938 inch 23,83 mm	1.0 inch 25,4 mm	1,062 inch 26,97 mm	1,188 inch 30,15 mm
10 3/4" 273 mm	Rp	9,5	9,1	8,9	8,8	8,7	8,6	8,4	8,3	8	7,9	7,8	7,6
	Hp	8,9	8,8	8,5	8,4	8,3	8,2	8,1	7,9	7,7	7,6	7,5	7,2
	F+C	25	42,6	86,3	114,4	147,6	182,5	240,1	171	230,5	258,5	289,8	354,5
12 3/4" 323,8 mm	Rp	11	11	10,7	10,6	10,5	10,4	10,2	10,1	9,8	9,7	9,6	9,4
	Hp	10,6	10,5	10,3	10,2	10,1	9,9	9,8	9,6	9,4	9,3	9,2	9
	F+C	28,3	51,2	103,6	138,5	175,2	217,1	284,7	210,8	350	391,8	438,9	538,3
14" 355,6 mm	Rp	12,5	12,1	11,9	11,7	11,6	11,5	11,3	11,2	10,9	10,5	10,7	10,2
	Hp	11,7	11,6	11,4	11,2	11,1	11	10,9	10,7	10,5	10	10,3	9,7
	F+C	31,3	55,8	113,5	153,6	193,8	239,1	314	232,8	386	418,6	483,6	586,9
16" 406,4 mm	Rp	14,3	13,9	13,7	13,5	13,4	13,3	13,2	13	12,8	12,2	12,5	11,9
	Hp	13,4	13,3	13,1	13	12,9	12,8	12,6	12,5	12,2	11,7	12	11,4
	F+C	36,3	62,6	129	174,3	221,4	273,6	360,4	267,4	443,1	480,5	556,3	675,6
18" 457,2 mm	Rp	16,2	15,7	15,5	15,4	15,2	15,1	15	14,8	14,6	14	14,3	13,6
	Hp	15,1	15	14,8	14,7	14,6	14,5	14,3	14,2	13,9	13,4	13,7	13,1
	F+C	39,8	71,2	146,3	196,8	249	308,3	405,8	291,6	500,2	544,1	629	747,6
20" 508 mm	Rp	18	17,5	17,3	17,2	17	16,9	16,8	16,8	16,4	15,7	16,1	15,4
	Hp	16,9	16,8	16,5	16,4	16,3	16,2	16,1	15,9	15,7	15	15,5	14,7
	F+C	44,8	78,1	161,7	219,2	276,7	342,8	452,4	324,3	557,4	606,1	701,8	834,8
22" 558,8 mm	Rp	19,9	19,3	19,1	19	18,9	18,7	18,6	18,4	17,6	17,5	18	17,1
	Hp	18,6	18,5	18,3	18,2	18,1	17,9	17,8	17,6	16,8	16,7	17,2	16,4
	F+C	49,9	86,6	179	241,7	306,1	377,4	497,5	357,2	594	669,7	774,6	921,9
24" 609,6 mm	Rp	21,7	21,1	20,9	20,8	20,7	20,5	20,4	20,2	20	19,2	19,9	18,9
	Hp	20,3	20,2	20	19,9	19,8	19,7	19,5	19,4	19,1	18,4	18,9	18,1
	F+C	53,3	95,1	194,4	264,1	333,7	412	544,2	391,8	671,6	731,6	847,3	1003,3
26" 660,9 mm	Rp	23,6	22,9	22,7	22,6	22,5	22,4	22,2	22,1	21,8	21	21,6	20,6
	Hp	22,1	22	21,8	21,6	21,5	21,4	21,3	21,1	20,9	20,1	20,7	19,8
	F+C	58,3	102	211,7	284,8	361,3	448,2	589,1	424,6	730,4	795,2	919,9	1096,1
28" 711,2 mm	Rp	25,4	24,7	24,5	24,4	24,3	24,2	24	23,8	23,6	22,7	23,4	22,4
	Hp	23,8	23,7	23,5	23,3	23,2	23,1	23	22,8	22,6	21,7	22,4	21,4
	F+C	61,7	110,5	227,2	307,2	388,9	482	635,9	457,5	785,8	857,1	991,1	1181,5
30" 762 mm	Rp	27,3	26,5	26,3	26,2	26,1	26	25,8	25,7	25,4	24,4	25,2	24,1
	Hp	25,5	25,4	25,2	25,1	25	24,9	24,7	24,6	24,3	23,4	24,1	23,1
	F+C	68,6	117,3	242,7	329,7	418,3	517,5	680,8	490,4	843	919,1	1063,8	1269,9
32" 812,8 mm	Rp	29,1	28,3	29,1	28	27,9	27,8	27,6	27,5	27,2	26,2	27	25,9
	Hp	27,2	27,1	26,9	26,8	26,7	26,6	26,4	26,3	26	25,1	25,8	24,8
	F+C	71,9	125,9	259,9	352,1	446	552,1	727,6	524,9	901,9	981,1	1136,6	1347,9
34" 863,6 mm	Rp	31	30,1	29,9	29,8	29,7	29,6	29,4	29,3	29	27,9	28,8	27,6
	Hp	29	28,9	28,7	28,5	28,4	28,3	28,2	28	27,8	26,7	27,6	26,4
	F+C	75,2	134,5	275,4	374,6	473,7	586,6	772,6	557,8	959	1044,7	1209,3	1434,4
36" 914,4 mm	Rp	32,8	32	31,7	31,6	31,5	31,4	31,2	31,1	30,8	29,7	30,6	29,4
	Hp	30,7	30,6	30,4	30,3	30,2	30	29,9	29,7	29,5	28,4	29,3	28,1
	F+C	80,3	141,3	292,6	395,3	501,3	621,2	819,3	590,6	1016,1	1106,6	1282	1519,8
38" 965,2 mm	Rp	33,8	33,5	33,4	33,3	33,3	33,2	33	32,9	32,6	31,4	32,4	31,1
	Hp	32,3	32,1	32	31,9	31,8	31,6	31,5	31,5	31,2	30,1	31	29,8
	F+C	149,9	308,1	417,7	527,2	655,8	864,3	1107,3	623,5	1073,3	1170,2	1354,8	1606,8
40" 1016 mm	Rp	35,6	35,3	35,2	35,1	35,1	35	34,8	34,7	34,4	33,2	34,2	32,8
	Hp	34	33,8	33,7	33,6	33,5	33,5	33,3	33,2	33	31,8	32,8	31,5
	F+C	156,7	325,4	440,1	558,3	690,4	911	1130,4	656,3	1130,4	1232,1	1427,5	1692,3
42" 1066,8 mm	Rp	37,4	37,2	37	36,9	36,8	36,6	36,6	36,5	36,2	34,9	36	34,6
	Hp	35,8	35,6	35,5	35,3	35,2	35,1	34,9	34,9	34,7	33,4	34,5	33,1
	F+C	165,2	340,8	462,6	585,9	725	956	1187,5	690,8	1187,5	1294	1500,3	1779,3
44" 1117,6 mm	Rp	39,2	39	38,8	38,7	38,6	38,4	38,4	38	38	37,9	37,8	37,6
	Hp	37,5	37,3	37,2	37,1	37	36,8	35,4	36,4	36,3	36,2	36	
	F+C	172	356,3	483,3	613,6	759,5	1002,8	1273,2	723,2	1244,7	1404,5	1572,9	1939,5
46" 1168,4 mm	Rp	41	40,8	40,6	40,5	40,4	40,2	40,2	40,1	39,9	38,4	39,6	38,1
	Hp	39,2	39	38,9	38,8	38,7	38,5	38,4	38,4	38,2	36,8	37,9	36,5
	F+C	180,6	372,6	505,7	641,2	794,1	1047,7	1301,9	756,6	1301,9	1419,6	1591,8	1962
48" 1219,2 mm	Rp	42,8	42,6	42,4	42,3	42,2	42,1	42,1	41,9	41,7	41,5	41,4	41,2
	Hp	41	40,8	40,6	40,5	40,4	40,3	40,1	40,1	39,9	39,8	39,7	39,5
	F+C	189,1	389,1	528,1	670,6	830,4	1094,5	1401,1	1001,1	1359	1532,7	1718,5	2119,7
50" 1270 mm	Rp	44,6	44,4	44,3	44,1	44	43,9	43,7	43,7	43,5	43,4	43,2	43
	Hp	42,7	42,5	42,4	42,3	42,2	42,2	42	41,9	41,6	41,5	41,4	41,2
	F+C	196	406,3	550,6	698,3	865,1	1141,1	1442,6	1042,6	1417,8	1598,4	1789,5	2209,8
56" 1422,4 mm	Rp	50	49,8	49,7	49,6	49,4	49,3	49,1	48,9	48,8	48,7	48,4	
	Hp	47,9	47,7	47,6	47,5	47,3	47,2	47	46,8	46,7	46,6	46,4	
	F+C	219,9	454,5	616,1	781,1	968,8	1277,9	1668,9	1168,9	1589,2	1792,4	2007,8	2478,4
60" 1524 mm	Rp	53,6	53,4	53,3	53,2	53,1	52,9	52,7	52,7	52,5	52,4	52,3	52
	Hp	51,3	51,1	51	50,9	50,8	50,6	50,5	50,5	50,3	50,2	50	49,8
	F+C	221,4	471,7	643,7	817,4	1015,3	1341,8	1729,4	1229,4	1674	1887,6	2115,1	2613,5

Electrode consumption in kg
Electrode weight for cellulosic electrodes. Calculation for 100 joints without wastage. Stub end loss 50 mm (2 inches).

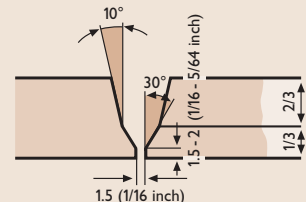
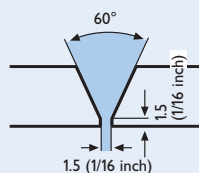

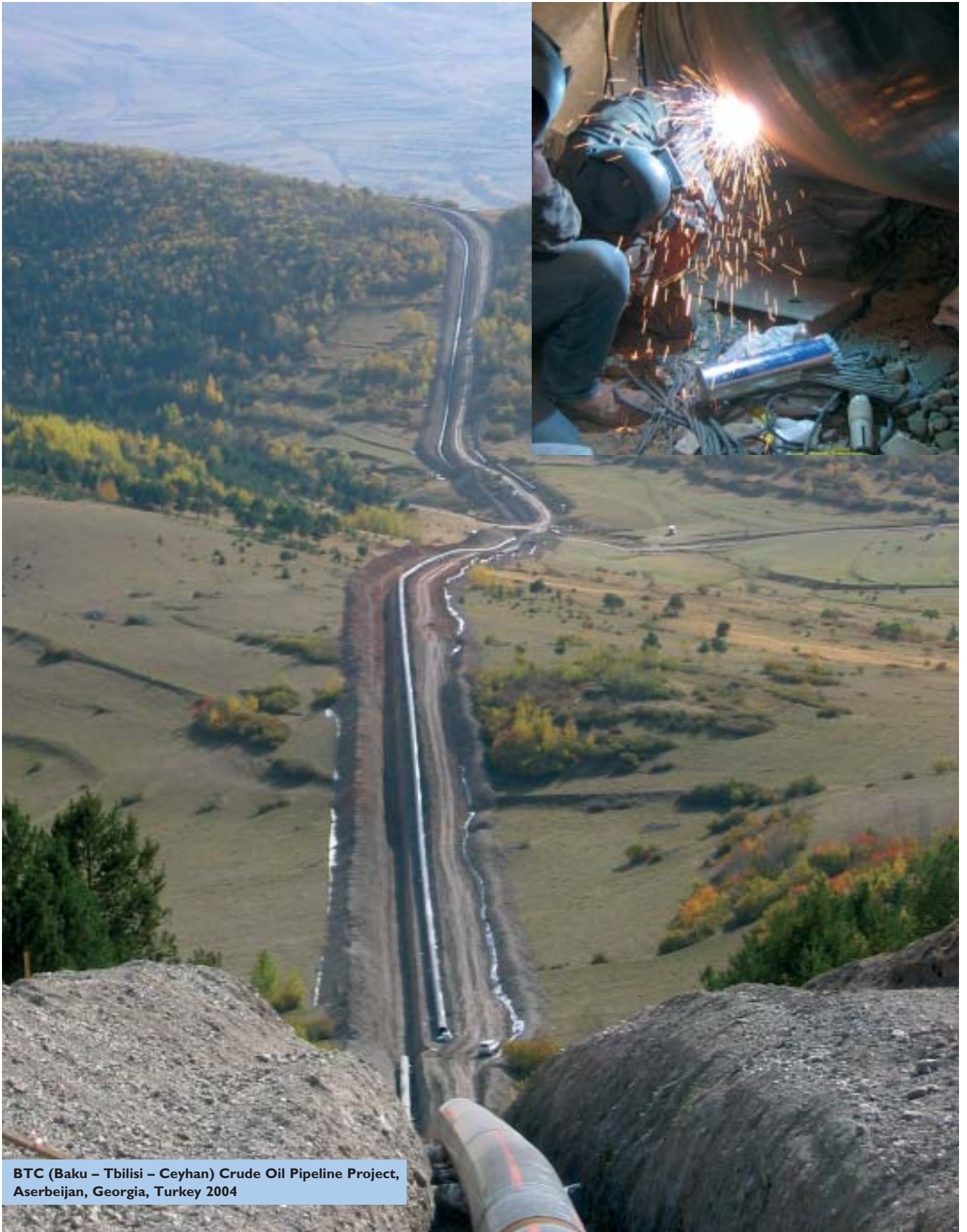

BTC (Baku - Tbilisi - Ceyhan) Crude Oil Pipeline Project, Aserbeijan, Georgia, Turkey 2004

Recommendations for basic coated electrodes

Steel grades API	Basic coated electrodes				
	FOX BVD E 8018-G	FOX BVD 85 E 8018-G	FOX BVD 90 E 9018-G	FOX BVD 100 E 10018-G	FOX BVD 110 E 11018-G
A	for root pass welding only	for filler passes and capping			
B	for root pass welding only	for filler passes and capping			
X 42	for root pass welding only	for filler passes and capping			
X 46	for root pass welding only	for filler passes and capping			
X 52	for root pass welding only	for filler passes and capping			
X 56	for root pass welding only	for filler passes and capping			
X 60	for root pass welding only	for filler passes and capping			
X 65	for root pass welding only	for filler passes and capping			
X 70	for root pass welding only		for filler passes and capping		
X 80	for root pass welding only		for filler passes and capping	for filler passes and capping	
X 100	for root pass welding only				for filler passes and capping
Steel grades EN					
L210	for root pass welding only	for filler passes and capping			
L245MB	for root pass welding only	for filler passes and capping			
L290MB	for root pass welding only	for filler passes and capping			
L320M	for root pass welding only	for filler passes and capping			
L360MB	for root pass welding only	for filler passes and capping			
L385M	for root pass welding only	for filler passes and capping			
L415MB	for root pass welding only	for filler passes and capping			
L450MB	for root pass welding only	for filler passes and capping	for filler passes and capping		
L485MB	for root pass welding only		for filler passes and capping		
L555MB	for root pass welding only			for filler passes and capping	

for root pass welding only
 for filler passes and capping

Basic coated vertical down electrodes are characterized by their favourable mechanical and technological features and by their low hydrogen contents ($HD < 5 \text{ ml/100 g}$). Welding time is the same in comparison with filler and cover passes as for welding using cellulose coated electrodes. However, there are losses in economy when welding root passes. It is therefore recommended that root and hot passes be welded with cellulose coated electrodes and the filler and cover passes with

basic coated vertical down electrodes. Low hydrogen vertical down electrodes are used in the welding of thick walled joints and for the welding of steels like API X 80 or X 100 as well as for the welding of joints with high impact strength requirements.

A further field of application is in above ground installation (AGI) and pipe laying tasks (e.g. landfall sections), where the use of cellulose coated electrodes is prohibited.

Basic coated electrodes for vertical down welding

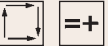
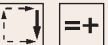
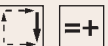
BÖHLER Standard Operating data	Welding process	Typical analysis %	Typical mechanical properties	Sizes mm	Amperage A	Approvals	Characteristics and applications	Base metals Standard Classification EN API
FOX BVD RP EN 499:1994 E 46 3 B 4 1 H5 AWS A5.5-96: E8018-G  Re-drying if necessary: 300-350 °C, min. 2 h. Note our recommendations on pages 18 and 22.	SMAW	C 0.05 Si 0.3 Mn 1.0	Re 510 (≥ 460) N/mm ² Rm 560 (550-650) N/mm ² A5 26 (≥ 22) % Av +20°C: 170 (≥ 130) J ±0°C: 150 J -20°C: 120 J -30°C: 60 (≥ 47) J YS 74000 (≥ 67000) PSI TS 81200 (≥ 80000-94000) PSI Elongation on 4d 26 (≥ 22) % Impact energy +68°F: 125 (≥ 96) ft-lb +32°F: 111 ft-lb -4°F: 89 ft-lb -22°F: 44 (≥ 35) ft-lb	2.5 3.2	80-110 100-160	TÜV-D, UDT, SEPROZ	Basic coated electrode for vertical down welding of root passes in pipeline construction and structural work. Also suitable for vertical-up welding of root passes. The deposit is extremely crack resistant and features high toughness and a very low hydrogen content (HD<5ml/100g). Highly economical compared with conventional verticalup welding. It can be used in sour gas applications (HIC-Test acc. NACE TM-02-84). Test values for SSC-test are available too.	Root passes for following steels: S235J2G3 up to S355J2G3, L290NB up to L415NB, L290MB up to L555MB, P235GH up to P310GH API Spec. 5 L: Root passes for following steels: X 42, X 46, X 52, X 56, X 60, X 70, X 80
FOX BVD 85 EN 499:1994 E 46 5 1Ni B 4 5 H5 AWS A5.5-96: E8018-G  Re-drying if necessary: 300-350 °C, min. 2 h. Note our recommendations on pages 18 and 22.	SMAW	C 0.04 Si 0.4 Mn 0.9 Ni 0.9	Re 510 (≥ 460) N/mm ² Rm 560 (550-650) N/mm ² A5 27 (≥ 22) % Av +20°C: 170 (≥ 130) J ±0°C: 150 J -20°C: 120 J -40°C: 85 (≥ 60) J -50°C: 65 (≥ 47) J YS 74000 (≥ 67000) PSI TS 81200 (≥ 80000-94000) PSI Elongation on 4d 27 (≥ 22) % Impact energy +68°F: 125 (≥ 96) ft-lb +32°F: 111 ft-lb -4°F: 89 ft-lb -40°F: 63 (≥ 45) ft-lb -58°F: 48 (≥ 35) ft-lb	3.2 4.0 4.5	110-160 180-210 200-240	TÜV-D, CL, GdF, UDT, SEPROZ	Basic coated electrodes for vertical down welds of large diameter pipelines and for structural work. Suitable for filler and cover pass welding in pipeline construction. Deposit is extremely crack resistant, and features high toughness and a very low hydrogen content (HD<5ml/100g). Deposition rate is 80-100 % higher than for vertical up welding. The weld deposit of BÖHLER FOX BVD 85 shows an ideal combination between high strength and cryogenic toughness down to -50 °C (-58 °F). Special design and development work has enabled this electrode to provide exceptional striking characteristics and the avoidance of start porosity on cover (cap) passes. Due to this and the good welding characteristics this special basic electrode offers easy handling even under field conditions. It can be used in sour gas applications (HIC-Test acc. NACE TM-02-84). Test values for SSC-test are available too.	S235J2G3 up to S355J2G3, L290NB up to L450NB, L290MB up to L450MB, P235GH up to P295GH API Spec. 5 L: A, B, X 42, X46, X 52, X 56, X 60, X 65
FOX BVD 90 EN 757:1997 E 55 5 Z2Ni B 4 5 H5 AWS A5.5-96: E9018-G  Re-drying if necessary: 300-350 °C, min. 2 h. Note our recommendations on pages 18 and 22.	SMAW	C 0.04 Si 0.3 Mn 1.2 Ni 2.2	Re 600 (≥ 550) N/mm ² Rm 650 (620-720) N/mm ² A5 27 (≥ 20) % Av +20°C: 170 (≥ 120) J ±0°C: 145 J -20°C: 130 J -40°C: 110 J -50°C: 80 (≥ 47) J YS 87000 (≥ 80000) PSI TS 94000 (≥ 90000-104000) PSI Elongation on 4d 27 (≥ 20) % Impact energy +68°F: 127 (≥ 89) ft-lb +32°F: 107 ft-lb -4°F: 96 ft-lb -40°F: 82 ft-lb -58°F: 60 (≥ 35) ft-lb	3.2 4.0 4.5	110-160 180-210 200-240	TÜV-D, CL, Statoil, UDT, GdF, SEPROZ	Basic coated electrodes for vertical down welds of large diameter pipelines and for structural work. Suitable for filler and cover pass welding in pipeline construction. Deposit is extremely crack resistant, and features high toughness and a very low hydrogen content (HD<5ml/100 g). Special design and development work has enabled this electrode to provide exceptional striking characteristics and the avoidance of start porosity on cover (cap) passes. Due to this and the good welding characteristics this special basic electrode offers easy handling even under field conditions. Deposition rate is 80-100 % higher than for vertical up welding.	L485MB, L555MB API Spec. 5 L: X 70, X 80

Basic coated electrodes for vertical down welding

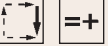
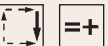
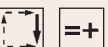
BÖHLER Standard Operating data	Welding process	Typical analysis %	Typical mechanical properties	Sizes mm	Amperage A	Approvals	Characteristics and applications	Base metals Standard Classification EN API
FOX BVD 100 EN 757:1997 E 62 5 Z2Ni B 4 5 H5 AWS A5.5-96: E10018-G  Re-drying if necessary: 300-350 °C, min. 2 h. Recommended interpass temperature > 100 °C. Note our recommendations on pages 18 and 22.	SMAW	C 0.07 Si 0.4 Mn 1.2 Ni 2.3	Re 670 (≥ 620) N/mm ² Rm 730 (690-810) N/mm ² A5 24 (≥ 18) % Av +20°C: 150 (≥ 110) J ±0°C: 125 J -20°C: 120 J -50°C: 70 (≥ 47) J YS 97000 (≥ 90000) PSI TS 105800 (≥ 100000-117000) PSI Elongation on 4d 24 (≥ 18) % Impact energy +68°F: 111 (≥ 81) ft-lb 32°F: 92 ft-lb -4°F: 89 ft-lb -58°F: 52 (≥ 35) ft-lb	4.0 4.5	180-210 200-240	TÜV-D, UDT, SEPROZ	Basic coated electrodes for vertical down welds of large diameter pipelines and for structural work. Suitable for filler and cover pass welding in pipeline construction. Deposit is extremely crack resistant, and features high toughness and a very low hydrogen content (HD <5 ml/100 g). Special design and development work has enabled this electrode to provide exceptional striking characteristics and the avoidance of start porosity on cover (cap) passes. Due to this and the good welding characteristics this special basic electrode offers easy handling even under field conditions. Deposition rate is 80-100 % higher than for vertical up welding.	L555MB API Spec. 5 L: X 80
FOX BVD 110 EN 757:1997 E 69 3 Mn2NiMo B 4 5 H5 AWS A5.5-96: E11018-G  Re-drying if necessary: 300-350 °C, min. 2 h. Recommended interpass temperature > 110 °C. Note our recommendations on pages 18 and 22.	SMAW	C 0.07 Si 0.4 Mn 1.5 Ni 2.0 Mo 0.3	Re 720 (≥ 690) N/mm ² Rm 810 (≥ 760) N/mm ² A5 20 (≥ 17) % Av +20°C: 90 (≥ 80) J -20°C: 70 (≥ 50) J -40°C: 50 (≥ 40) J YS 104000 (≥ 100000) PSI TS 117000 (≥ 110000) PSI Elongation on 4d 20 (≥ 17) % Impact energy +68°F: 66 (≥ 60) ft-lb -4°F: 52 (≥ 37) ft-lb -40°F: 37 (≥ 30) ft-lb	4.0 4.5	180-210 200-240	SEPROZ	Basic coated electrodes for vertical down welds of large diameter pipelines and for structural work. Suitable for filler and cover pass welding in pipeline construction. Deposit is extremely crack resistant, and features high toughness and a very low hydrogen content (HD <5 ml/100 g). Special design and development work has enabled this electrode to provide exceptional striking characteristics and the avoidance of start porosity on cover (cap) passes. Due to this and the good welding characteristics this special basic electrode offers easy handling even under field conditions. Deposition rate is 80-100% higher than for vertical up welding.	L690 ¹⁾ API Spec. 5 L: X100 ¹⁾ ¹⁾ not standardised yet
FOX BVD 120 EN 757:1997 E 69 3 Mn2NiMo B 4 5 H5 AWS A5.5-96: E12018-G  Re-drying if necessary: 300-350 °C, min. 2 h. Recommended interpass temperature > 120 °C. Note our recommendations on pages 18 and 22.	SMAW	C 0.07 Si 0.4 Mn 1.85 Ni 2.25 Mo 0.35	Re 815 (≥ 740) N/mm ² Rm 870 (≥ 830) N/mm ² A5 18 (≥ 17) % Av +20°C: 80 (≥ 80) J -20°C: 60 (≥ 50) J -40°C: 50 (≥ 40) J YS 118000 (≥ 107300) PSI TS 126000 (≥ 120300) PSI Elongation on 4d 18 (≥ 17) % Impact energy +68°F: 60 (≥ 60) ft-lb -4°F: 44 (≥ 37) ft-lb -40°F: 37 (≥ 30) ft-lb	3.2 4.0	110-160 180-220	—	Basic coated electrodes for vertical down welds of large diameter pipelines and for structural work. Suitable for filler and cover pass welding in pipeline construction. Deposit is extremely crack resistant, and features high toughness and a very low hydrogen content (according AWS condition HD<4ml/100 g). Deposition rate is 80-100 % higher than for vertical up welding. This stick electrode is optimised for best striking properties and for avoiding start porosity in the cap layer. With its excellent welding properties the electrode offers easy handling also under difficult conditions.	L690 ¹⁾ API Spec. 5 L: X100 ¹⁾ , X110 ¹⁾ ¹⁾ not standardised yet

Interpass Temperature

The interpass temperature influences the metallurgical processes that take place in the deposit during solidification and cooling and thus to a certain extent also the mechanical properties of the weld metal.

It is thus generally recommended that the **interpass temperature be maintained at approx. 100 °C ± 30 °C (210 °F ± 86 °F) throughout welding.**

Recommended joint preparation

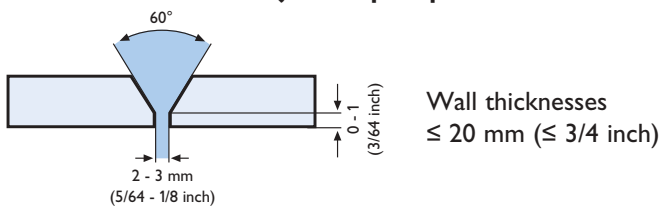

Welding machines

For welding pipe girth welds in pipeline construction, the basic coated vertical down electrodes can only be operated on direct current and positive polarity. Practical experience has shown that welding machines usually used for the welding of cellulose coated electrodes in pipe-line construction are also suitable for the welding of basic coated vertical down electrodes. The welding machines should have a drooping characteristic and a high open circuit voltage.

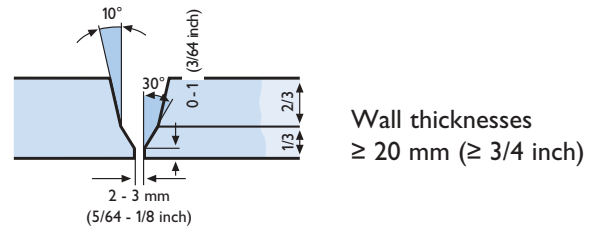

Preheating

Welding with basic coated electrodes with their relatively low hydrogen content involves less risk of hydrogen induced underbead cracking than if cellulosic electrodes are used.

Still, preheating to a temperature of approx. 100 °C (210 °F) is recommended, particularly for welding heavy wall pipe from steels that are susceptible to hardening. The diagram illustrates those cases for which preheating is recommended.

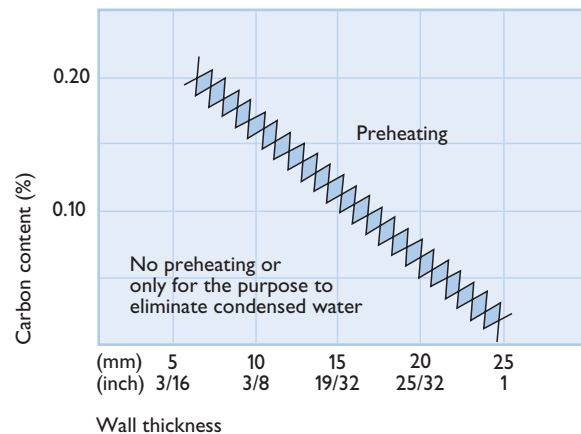

Preheating depending upon wall thickness and carbon content.

Basic coated electrodes

In cases where extra high toughness is required, extreme climatic conditions, heavy wall pipes (≥ 25 mm / ≥ 1 inch) e.g. landfall sections or the highest strength pipe steels StE 550.7 TM/X 80, X 100 there is a demand for low hydrogen vertical down electrodes.

BÖHLER WELDING offers four different grades matching all of the important requirements including the practical and economical demands in field welding large diameter pipelines.

Comparison of impact strength

Diagram no. 1 indicates the impact strength behaviour of vertical down welded joints and shows that the „basic coated deposit“ is clearly tougher. **The fact that the weld metal toughness of our of cellulose coated electrodes has improved considerable is shown with the example of FOX CEL 85 (E8010-P1).**

Diagram no. 2 gives an overview about the excellent economical benefits when welding filler and cover passes with basic coated vertical down electrodes.

Combined technology with cellulose and basic coated electrodes

Due to the high iron powder content of the basic coating and the ability to weld with high currents, **4 mm (5/32") diameter**

low hydrogen vertical down electrodes have approximately the same deposition rate as 5.5 mm (7/32") diameter cellulose electrodes. Therefore the time required for the welding of filler and cover passes is similar using cellulose or basic coated vertical down electrodes.

However, there are losses in economy when welding the root pass with basic coated vertical down electrodes.

It is therefore recommended and widely practiced, that **root and hot passes** be welded with **cellulose coated electrodes**, and **filler and cover passes** with **basic coated vertical down electrodes**.

It is thus possible to combine high economy with good mechanical-technological values in the joint weld.

A great deal of experience has been gained already using this technology with very positive results. Should you require further details please contact our Technical Department.

Diagram no. 1

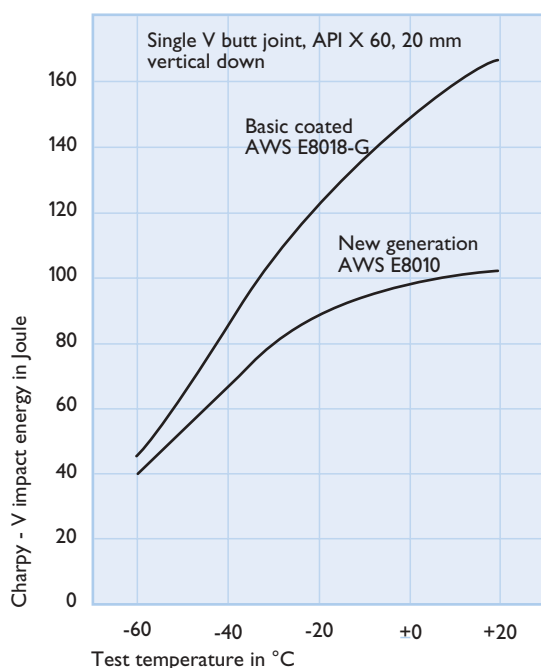
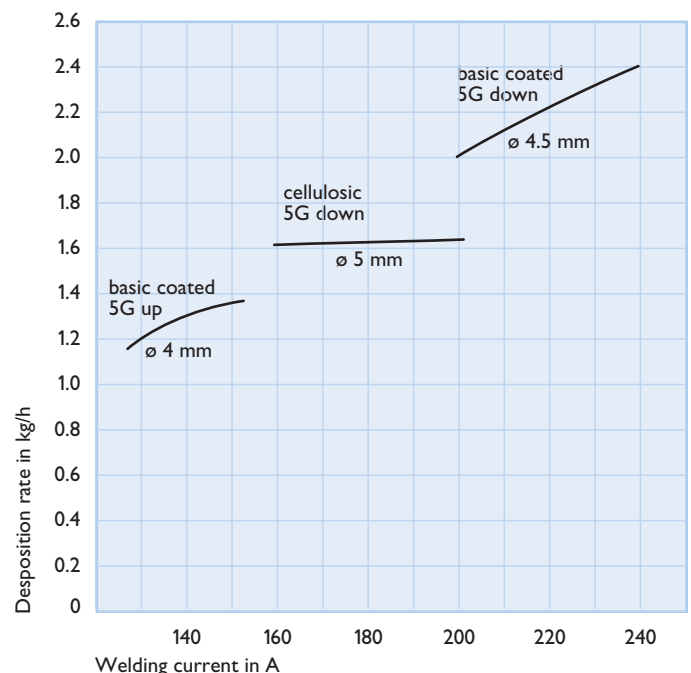

Diagram no. 2



D.C. positive

∅ 2.5 mm (3/32") 70 - 90 A
In welding position 10 - 14 o'clock 60 - 70 A

∅ 3.2 mm (1/8") 90 - 150 A
In welding position 10 - 14 o'clock 90 - 100 A

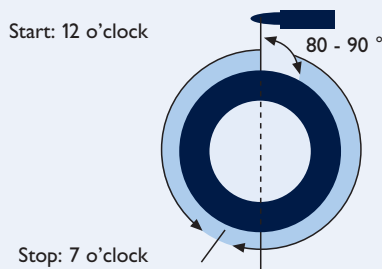

Short arc! Keep direct contact!

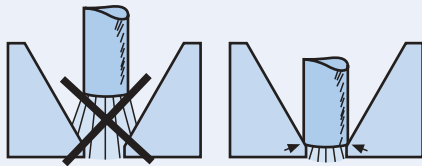

Avoid:
keyhole formation

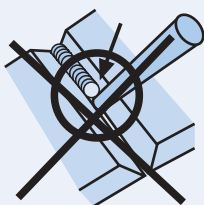

Correct:
no keyhole

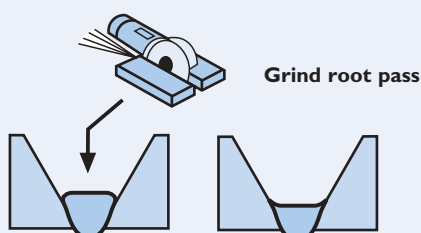
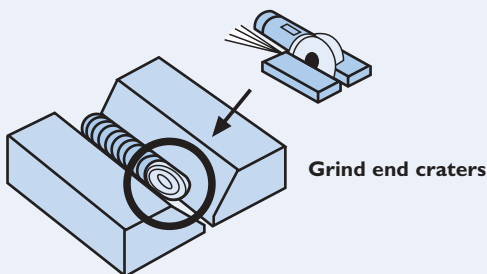
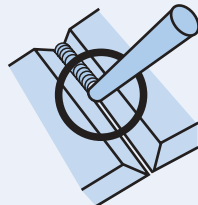

Stringer bead or root pass

All available grades of line pipe steels can be welded with **BÖHLER FOX BVD RP** if root pass welding with cellulosic electrodes is not permitted.

It has become general practice to have two or more welders work simultaneously in order to reduce distortion and maintain uniform gap width. **The recommended electrode diameter is 2.5 mm (3/32") or in the case of heavy walled large diameter pipes also 3.2 mm (1/8").** Maintain direct contact with the bevel faces. Grinding of the end crater should be carried out.

In order to avoid a change in the slag viscosity and to maintain excellent control of the slag, groove faces must be free from foreign matter such as scale or rust.

To prevent any porosity it is necessary to avoid any „key-hole“ formation during welding. Too high a current could cause this problem.

One should never finish root passes welded from two sides in 6 o'clock position. Termination of the runs should be approximately in the 7 o'clock position only.

It is recommended to operate the electrode with a short arc. Remove slag from each bead by grinding. A clean slag-free bead assures excellent slag control when welding the subsequent layers with basic coated electrodes.

Filler passes

These passes are executed with 3.2 mm, 4 mm and 4.5 mm dia electrodes, depending upon plate thickness. A diameter of 4 mm being preferred.

∅ 3.2 mm (1/8")	110 - 160 A
∅ 4 mm (5/32")	180 - 210 A
∅ 4.5 mm (3/16")	200 - 240 A

The high amperage ensures sufficient penetration and satisfactory economy of the process.

Avoid welding without weaving, as this would cause the pool to move faster than the electrode, short-circuiting the arc for a considerable time and making the electrode stick. This has a negative effect on the deoxidation process and favours porosity. Experienced welders will know which weave width and weld speed to choose, also taking into account the slag flow.

In the overhead position, width of weaving is limited by manipulation.

For welding heavy wall pipe we recommend to deposit 2 to 3 beads side by side, removing all slag before applying a new

Basic coated electrodes

bead. If slag residuals are covered by a new bead, in 3 o'clock position in particular, the whole slag pool will flow ahead of the arc.

Keep the arc as short as possible.

To avoid any hardening peaks it is recommended that the last filler pass should be flush with the pipe surface so that the edges of the joint preparation are melted. This is to ensure that the capping pass when deposited tempers the heat affected zone.

Cap

The cap is deposited with a slight weaving technique, with a maximum weave of twice the electrode diameter.

Recommended amperages:

∅ 3.2 mm (1/8")	110 - 160 A
∅ 4 mm (5/32")	180 - 210 A

Rules for storage and rebaking of basic coated electrodes

Electrodes which have been stored in sealed cans do not need to be rebaked.

Once a can has been opened, the electrodes it contains should be kept in a closed electrode container, until they are used for welding.

Electrodes which are taken from unsealed, damaged cans or those which have been kept in open storage for several hours should be rebaked at 300 - 350 °C (570 - 660 °F) for 2 hours minimum and 10 hours maximum.

In the event of rel. air humidity of more than 70 % it is recommended to use heated quivers maintaining a temperature of 100 - 200 °C (210 - 400 °F) prior to use.

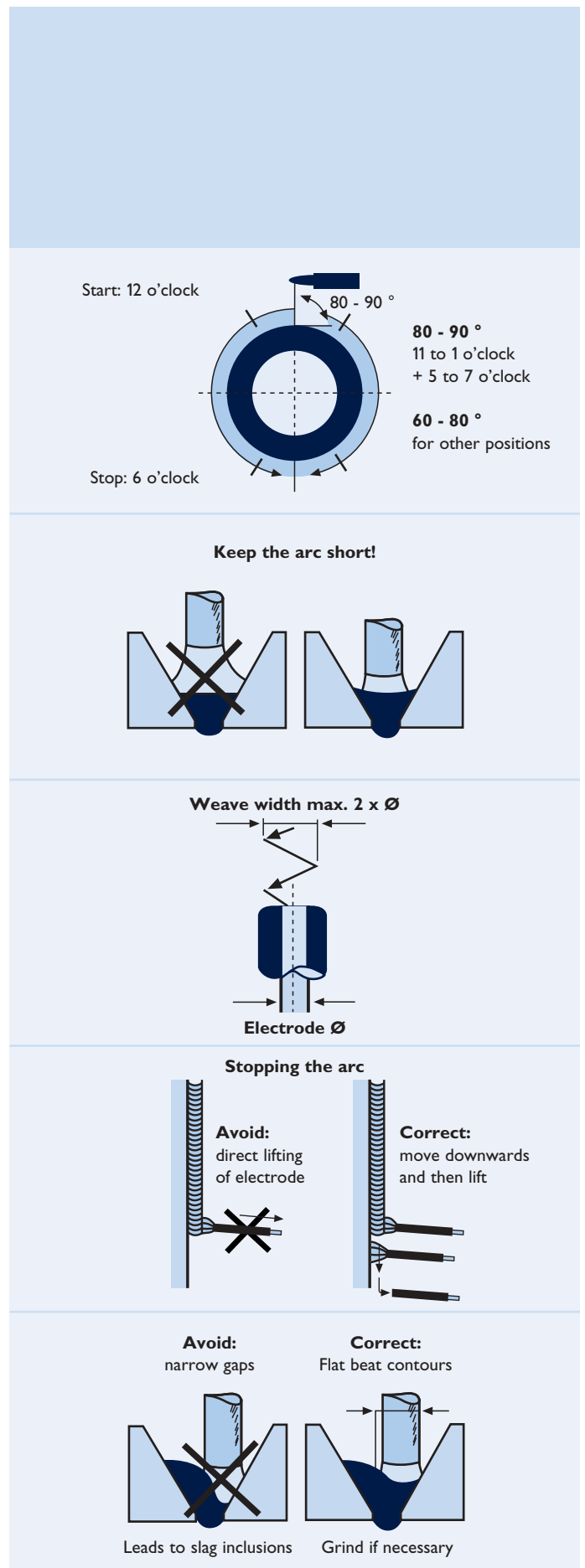

Welding technology – Basic coated electrodes

Wall thickness		Electrode consumption (kg)			
in.	mm	∅ 2.5 mm 3/32 inch	∅ 3.2 mm 1/8 inch	∅ 4 mm 5/32 inch	Total
11/64	14.36	0.30			0.30
13/64	15.16	0.20	0.20		0.40
1/4	16.35	0.20	0.35		0.55
5/16	17.93	0.20	0.65		0.85
3/8	19.52		0.20	0.90	1.10
1/2	12.70		0.20	1.55	1.75
5/8	15.88		0.20	2.45	2.65
11/16	17.46		0.20	2.95	3.15
3/4	19.04		0.20	3.50	3.70
13/16	20.63		0.20	4.00	4.20
7/8	22.22		0.20	4.75	4.95
15/16	23.81		0.20	5.40	5.60
1	25.40		0.20	6.00	6.20

Wall thickness		Electrode consumption (kg)		
in.	mm	∅ 3.2 mm 1/8 inch	∅ 4 mm 5/32 inch	Total
13/16	20.63	0.20	2.60	2.80
7/8	22.22	0.20	3.00	3.20
15/16	23.81	0.20	3.40	3.60
1	25.40	0.20	3.90	4.10

*) For quantities see Chapter on „Form of supply“ in the individual description of electrode brands.

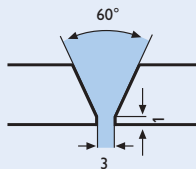

*) For quantities see Chapter on „Form of supply“ in the individual description of electrode brands. 1 kg = 2.205 pounds (lbs)

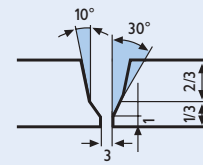

Trouble shooting	Defects	Causes	How to avoid defects
	Start porosity	<ul style="list-style-type: none"> use of damp electrodes drawing a long arc after ignition use of electrodes with damaged striking tips 	<ul style="list-style-type: none"> use only dry (rebaked) electrodes keep the arc short use undamaged electrodes use ignition active BÖHLER electrodes
	Lack of fusion	<ul style="list-style-type: none"> welding over slag residues insufficient grinding of undercut amperage too low 	<ul style="list-style-type: none"> precise inter run cleaning by grinding or brushing grind sufficiently any undercut increase the amperage
	Sagging stringer bead	<ul style="list-style-type: none"> amperage too high electrode diameter too large poor joint preparation root gap too narrow 	<ul style="list-style-type: none"> set a lower amperage use of smaller electrode diameter joint preparation according to recommendation
	Striking marks	<ul style="list-style-type: none"> stray arcing outside joint preparation causes local hardening 	<ul style="list-style-type: none"> strike arc in the groove only
	Slag inclusions	<ul style="list-style-type: none"> insufficient cleaning between passes 	<ul style="list-style-type: none"> clean each layer with rotating wire brush
	Scattered porosity	<ul style="list-style-type: none"> use of damp electrodes prolonged short circuit due to use of welding machines with poor welding characteristics poor electrode manipulation e.g. arc too long, angle incorrect 	<ul style="list-style-type: none"> use only dry (rebaked) electrodes check the welding machine (open circuit voltage etc) handle the electrode correctly e.g. keep the arc short, keep the angle of 80 - 90 °

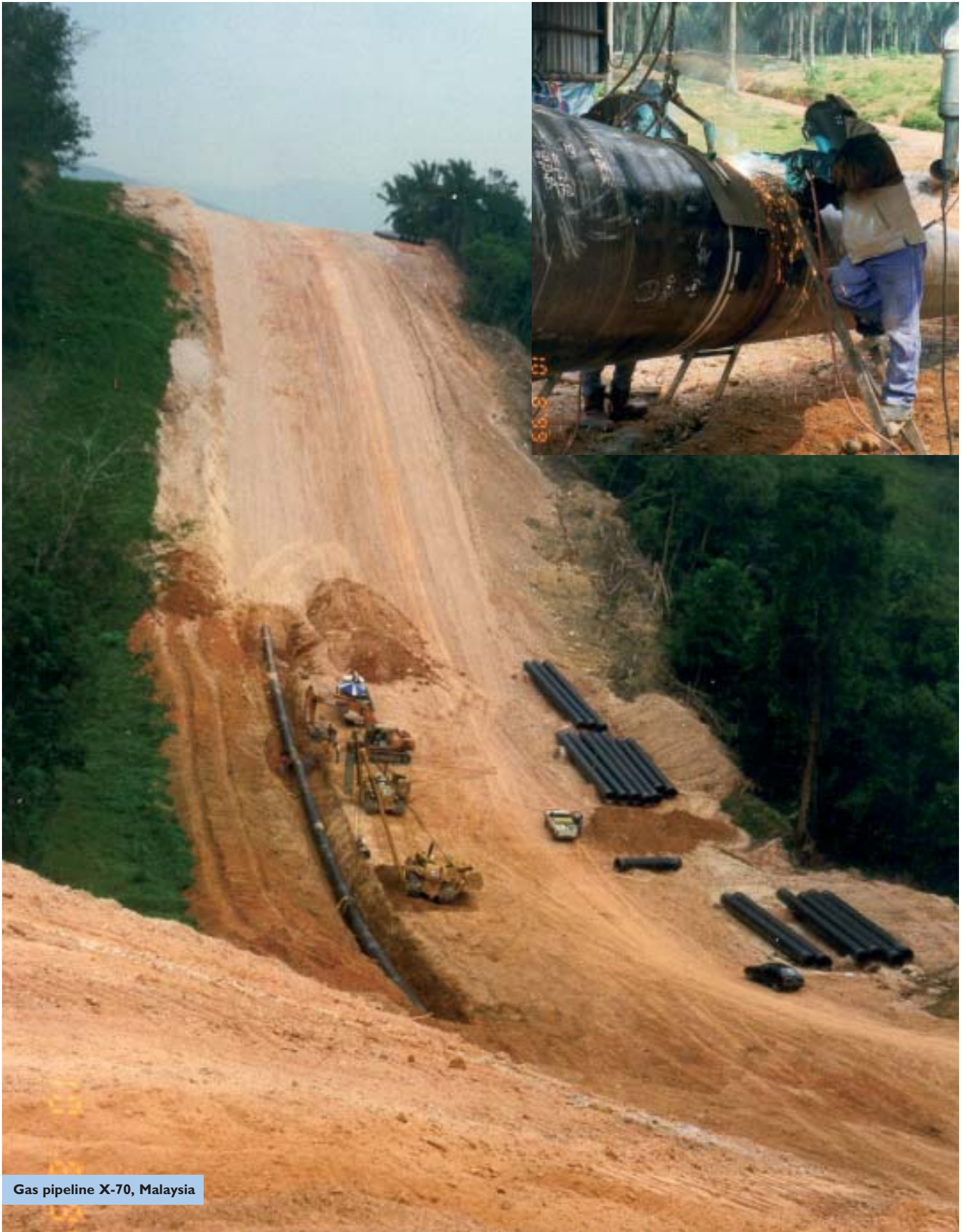

Gas pipeline X-70, Malaysia

Recommendations for basic coated vertical up electrodes

Steel grades API	Basic coated electrodes		
	FOX EV Pipe E 7016-1	FOX EV 60 Pipe E 8016-G	FOX EV 70 Pipe E 9016-G
A	■		
B	■		
X 42	■	■	
X 46	■	■	
X 52	■	■	
X 56	■	■	
X 60	■	■	
X 65	■	■	■
X 70	■		■
X 80	■		■
Steel grades EN			
L210	■		
L245	■		
L290MB	■	■	
L320M	■	■	
L360MB	■	■	
L385M	■	■	
L415MB	■	■	
L450MB	■	■	■
L485MB	■		■
L555MB	■		■

■ for root pass, hot pass and filler passes and capping

■ for root pass welding only

Compared to root pass welding with cellulosic-coated vertical-down electrodes the welder has to face a welding speed reduction of 60-70 % when welding the same root pass with basic-coated vertical-up electrodes. Nevertheless new product developments show a welding behaviour which allows the economic production of joints. BÖHLER FOX EV Pipe products guarantees significant advantages in positional welding:

- Usability of a diameter 4.0 mm up to a wall thicknesses equal or above 12 mm.

- Better and easier operating properties compared to a standard E7018-type.
- Obvious economic advantages for cap layers.
- Reduced grinding work compared to E7018 electrodes.

Furthermore these products exhibit high mechanical load capacity, lowest hydrogen contents in deposit, good air gap bridgeability, best toughness values and highest tensile strength properties (if required).

Basic coated electrodes for vertical up welding

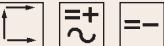
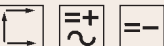
BÖHLER Standard Operating data	Welding process	Typical analysis %	Typical mechanical properties	Sizes mm	Amperage A	Approvals	Characteristics and applications	Base metals Standard Classification EN API
<p>FOX EV PIPE</p> <p>EN 499:1994 - E 42 4 B 1 2 H5</p> <p>AWS A5.1-04: E7016-1 H4 R AWS A5.1M-04: E4916-1 H4 R</p>  <p>Polarity negative for root pass.</p> <p>Preheat and interpass temperature as required by the base material. The optimum gap width for root passes is 2-3mm, the root face should be in the range 2-2.5 mm. The electrodes are ready for use straight from the hermetically sealed tins.</p> <p>Re-drying if necessary: 300-350 °C, min. 2 h.</p>	SMAW	<p>C 0.06 Si 0.60 Mn 0.9 Ni 0.17</p>	<p>Re 470 (≥ 420) N/mm² Rm 560 (≥ 520-640) N/mm² A5 29 (≥ 22) %</p> <p>Av +20°C: 170 (≥ 120) J -20°C: 100 J -40°C: 60 (≥ 47) J -46°C: 55 (≥ 27) J</p> <p>YS 68000 (≥ 61000) PSI TS 81200 (≥ 74000-92800) PSI Elongation on 4d 29 (≥ 22) %</p> <p>Impact energy +68°F: 125 (≥ 89) ft-lb -4°F: 74 ft-lb -40°F: 44 (≥ 35) ft-lb -51°F: 40 (≥ 20) ft-lb</p>	2.0 2.5 3.2 4.0	30-60 40-90 60-130 110-180	TÜV-D, CL, UDT, LTSS, SEPROZ, VNIIST, VNIIGAZ	<p>BÖHLER FOX EV PIPE is a basic coated electrode with some additions of rutile and silicates. It is excellent suited for positional welding of root passes using D. C. negative polarity as well as for filler and cover passes of pipes, tubes and plates on D. C. positive polarity, or even AC. BÖHLER FOX EV PIPE offers considerable time savings against AWS E 7018 type electrodes when welding root passes due to increased travel speeds. Also the use of dia. 3.2 mm is possible for root passes in case of wall thicknesses of 8 mm and more. It is user friendly and provides a good gap bridging ability together with easy slag removal to ensure minimum grinding. Weld metal toughness is available down to -46°C; very low hydrogen content (HD < 5 ml/100 g).</p>	<p>P235GH, P265GH, P295GH, P235T1, P275T1, P235G2TH, P255G1TH, S255N-S420N¹⁾, S255NL1 up to S420NL1, L290NB up to L360NB, L290MB up to L415MB, L450MB²⁾ up to L555MB³⁾</p> <p>API Spec. 5 L: A, B, X42, X46, X52, X56, X60, X65-X80²⁾</p> <p>ASTM: A53 Gr.A-B, A106 Gr.A-C, A179, A192, A210 Gr.A-1</p> <p>¹⁾ stress relieved up to S380N / S380NL1 ²⁾ only for root pass</p>
<p>FOX EV 60 PIPE</p> <p>EN 499:1994 E 50 4 1 Ni B 1 2 H5</p> <p>AWS A5.5-96: E8016-G H4 R</p>  <p>Polarity negative for root pass.</p> <p>Preheat and interpass temperature as required by the base material. The optimum gap width for root passes is 2-3 mm, the root face should be in the range 2-2.5 mm. The electrodes are ready for use straight from the hermetically sealed tins.</p> <p>Re-drying if necessary: 300-350 °C, min. 2 h.</p>	SMAW	<p>C 0.07 Si 0.60 Mn 1.2 Ni 0.9</p>	<p>Re 550 (≥ 500) N/mm² Rm 590 (560-720) N/mm² A5 29 (≥ 22) %</p> <p>Av +20°C: 170 (≥ 130) J ±0°C: 150 J -20°C: 140 J -40°C: 110 (≥ 47) J</p> <p>YS 80000 (≥ 72500) PSI TS 85600 (≥ 81200-104400) PSI Elongation on 4d 29 (≥ 22) %</p> <p>Impact energy +68°F: 125 (≥ 96) ft-lb +32°F: 111 ft-lb -4°F: 103 ft-lb -40°F: 81 (≥ 35) ft-lb</p>	2.5 3.2 4.0 5.0	40-90 60-130 110-180 180-230	VNIIGAZ	<p>Basic coated electrode excellent suited for positional welding of root passes using D.C. negative polarity as well as for filler and cover passes for pipes, tubes and plates on D.C. positive polarity, or even A.C. BÖHLER FOX EV 60 PIPE offers considerable time savings against AWS E 8018 type electrodes when welding root passes due to increased travel speeds. Also the use of dia. 3.2 mm is possible for root passes in case of wall thicknesses of 8 mm and more.</p> <p>Good impact properties down to -40 °C, low hydrogen content (HD < 5 ml/100 g), as well as packaging in hermetically sealed tins are further features for the user.</p>	<p>S235J2G3-S355J2G3, L210NB-L450NB, L210MB-L450MB, P235GH-P295GH, E295, E335, S355J2G3, C35-C45, P310GH, S380N-S460N, P380NH-P460NH, S380NL-S460NL, S380NL1-S460NL2, GE260-GE300</p> <p>API Spec. 5 L: X42, X46, X52, X56, X60, X65</p> <p>ASTM: A516 Gr.65, A572 Gr.55,60,65, A633 Gr.E, A612, A618 Gr.I, A537 Gr.1-3</p>
<p>FOX EV 70 PIPE</p> <p>EN 757:1997 E 55 4 Z (Mn2NiMo) B 1 2 H5</p> <p>AWS A5.5-96: E9016-G H4 R</p>  <p>Polarity negative for root pass.</p> <p>Preheat and interpass temperature as required by the base material. The optimum gap width for root passes is 2-3 mm, the root face should be in the range 2-2.5 mm. The electrodes are ready for use straight from the hermetically sealed tins.</p> <p>Re-drying if necessary: 300-350 °C, min. 2 h.</p>	SMAW	<p>C 0.06 Si 0.50 Mn 1.7 Ni 2.2 Mo 0.3</p>	<p>Re 620 (≥ 550) N/mm² Rm 680 (630-780) N/mm² A5 20 (≥ 18) %</p> <p>Av +20°C: 140 (≥ 90) J -20°C: 80 J -40°C: 70 (≥ 47) J</p> <p>YS 90000 (≥ 80000) PSI TS 98600 (≥ 91300-113100) PSI Elongation on 4d 20 (≥ 18) %</p> <p>Impact energy +68°F: 103 (≥ 66) ft-lb -4°F: 59 ft-lb -40°F: 52 ft-lb</p>	2.5 3.2 4.0	40-90 60-130 110-180	-	<p>BÖHLER FOX EV 70 PIPE is a high strength basic coated electrode. It is excellent suited for positional welding of root passes using D. C. negative polarity as well as for filler and cover passes of pipes, tubes and plates on D. C. positive polarity, or even AC.</p> <p>BÖHLER FOX EV 70 PIPE offers considerable time savings against AWS E9018 type electrodes when welding root passes due to increased travel speeds. Also the use of dia. 3.2 mm is possible for root passes in case of wall thicknesses of 8 mm and more.</p> <p>It is user friendly and provides a good gap bridging ability together with easy slag removal to ensure minimum grinding. Good impact properties down to -40 °C, low hydrogen content (HD < 5 ml / 100 g), as well as packaging in hermetically sealed tins are further features for the user.</p>	<p>L450MB, L485MB, L555MB</p> <p>API Spec. 5 L: X65, X70, X80</p>

Recommendations for automatic welding with solid wires

Steel grades API	Solid wires			
	SG 3-P ER 70S-6	K-Nova Ni ER 80S-G	NiMo 1-IG ER 90S-G	
X 42	■	■		
X 46	■	■		
X 52	■	■		
X 56	■	■		
X 60	■	■		
X 65	■	■		
X 70		■	■	
X 80			■	
Steel grades EN				
L290MB	■	■		
L320M	■	■		
L360MB	■	■		
L385M	■	■		
L415MB	■	■		
L450MB	■	■		
L485MB	■	■	■	
L555MB			■	
	■ for root pass, hot pass and filler passes and capping			

BÖHLER wire for Pipeline welding are especially intended for the needs of semiautomatic and automatic root, hot, fill and cap passes welding on cross-country pipelines.

They show on excellent mechanical properties, clean weld deposit, and uniform bead shape. The wires are suited for use on API 5L X42 through X80 pipes.

Wires for automatic pipeline welding

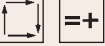
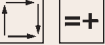
BÖHLER Standard Operating data	Welding process	Typical analysis %	Typical mechanical properties	Sizes mm	Amperage A	Approvals	Characteristics and applications	Base metals Standard Classification EN API
SG 3-P EN 440:1995 G4Si1 EN 440: G 46 5 M G0 G4Si1 G 42 4 C G0 G4Si1 AWS A5.18-01: ER70S-6 AWS A5.18M-01: ER485S-6  Shielding gases: Ar +15-25 % CO ₂ 100 % CO ₂ Preheating and interpass temperature as required by the base metal.	GMAW	C 0.05 Si 0.75 Mn 1.5 Ti +	as welded Ar +15-25 % CO₂ Re 510 (≥ 470) N/mm ² Rm 640 (600-680) N/mm ² A5 25 (≥ 24) % Av +20°C: 120 (≥ 100) J -40°C: 75 (≥ 65) J -50°C: 55 (≥ 47) J YS 74000 (≥ 68000) PSI TS 92800 (≥ 87000-98600) PSI Elongation on 4d 25 (≥ 24) % Impact energy +68°F: 89 (≥ 74) ft-lb -40°F: 55 (≥ 48) ft-lb -58°F: 40 (≥ 35) ft-lb as welded Ar +15-25 % CO₂ Re 470 (≥ 440) N/mm ² Rm 610 (570-640) N/mm ² A5 26 (≥ 25) % Av +20°C: 100 (≥ 95) -40°C: 60 (≥ 47) YS 68000 (≥ 63800) PSI TS 88400 (≥ 82600-92800) PSI Elongation on 4d 26 (≥ 25) % Impact energy +68°F: 74 (≥ 70) ft-lb -40°F: 44 (≥ 35) ft-lb	0.9	-	TÜV-D, UDT	BÖHLER SG 3-P is a micro alloyed GMAWV solid wire designed for high quality automatic welding of pipelines. An optimum balanced alloying concept ensures good weld metal properties to fulfil the high requirements in the On-Offshore-Pipeline Industry. Deposit is extremely crack resistant and the weld metal toughness is available down to -50 °C. The very important quality aspects, prerequisite for uninterrupted feedability of the solid wire e.g. helix of the wire, copper coating, close wire diameter tolerance and precision layer wound spooling are taken into account during the production.	L290MB-L485MB API Spec. 5 L: X42, X46, X52, X56, X60, X65
BÖHLER K-Nova Ni EN 440: G3Ni1 AWS A5.28-96: ER80S-G  Shielding gases: Ar +15-25 % CO ₂ Ar +0-5 % CO ₂ + 3-10 % O ₂ 100 % CO ₂ Preheating and interpass temperature as required by the base metal.	GMAW	C 0.06 Si 0.70 Mn 1.50 Ni 0.90 Ti +	as welded Ar +15-25 % CO₂ Re ≥ 500 N/mm ² Rm ≥ 590 N/mm ² A5 ≥ 24 % Av +20°C: ≥ 150 J -50°C: ≥ 80 J YS ≥ 72000 PSI TS ≥ 85000 PSI Elongation on 4d ≥ 24 % Impact energy +68°F: 110 ft-lb -58°F: 58 ft-lb as welded Ar +15-25 % CO₂ Re ≥ 470 N/mm ² Rm 560 N/mm ² A5 25 % Av +20°C: 110 J -50°C: 45 J YS 68000 PSI TS 81000 PSI Elongation on 4d ≥ 25 % Impact energy +68°F: ≥ 81 ft-lb -58°F: ≥ 35 ft-lb	0.9 1.0 1.2	-	DNV	Micro alloyed GMAW wire designed for high quality automatic welding of pipelines. An optimum balanced alloying concept ensures good weld metal properties to fulfil the high requirements in the On-Offshore pipeline industry. The deposit is extremely crack resistant and the weld metal offers high impact values down to -50 °C.	L290MB-L485MB API Spec. 5 L: X42, X46, X52, X56, X60, X65, X70

Wires for automatic pipeline welding

BÖHLER Standard Operating data	Welding process	Typical analysis %	Typical mechanical properties	Sizes mm	Amperage A	Approvals	Characteristics and applications	Base metals
<p>NiMo 1-IG</p> <p>EN 12534:1999 Mn3Ni1Mo (for wire)</p> <p>EN 12534:1999 G 55 6 M Mn3Ni1Mo G 55 4 C Mn3Ni1Mo</p> <p>AWS A5.28-96: ER90S-G</p>  <p>Shielding gases: Ar +15-25 % CO₂ Ar +0-5 % CO₂ +3-10 % O₂ 100 % CO₂</p> <p>Preheating and interpass temperature as required by the base metal.</p>	GMAW	C 0.08 Si 0.6 Mn 1.8 Mo 0.3 Ni 0.9	<p>as welded Ar +15-25 % CO₂</p> <p>Re 620 (≥ 550) N/mm² Rm 700 (650-800) N/mm² A5 23 (≥ 20) %</p> <p>Av +20°C: 140 (≥ 120) J -40°C: 110 (≥ 90) J -60°C: (≥ 47) J</p> <p>YS 89900 (≥ 80000) PSI TS 101500 (≥ 94000-116000) PSI Elongation on 4d 23 (≥ 20) %</p> <p>Impact energy +68°F: 103 (≥ 89) ft-lb -40°F: 82 (≥ 66) ft-lb -94°F: (≥ 35) ft-lb</p> <p>as welded Ar +15-25 % CO₂</p> <p>Re 590 (≥ 550) N/mm² Rm 680 (620-770) N/mm² A5 22 (≥ 20) %</p> <p>Av +20°C: 120 (≥ 100) -40°C: (≥ 47)</p> <p>YS 85500 (≥ 63800) PSI TS 98600 (≥ 89900) PSI Elongation on 4d 22 (≥ 25) %</p> <p>Impact energy +68°F: 89 (≥ 74) ft-lb -40°F: (≥ 35) ft-lb</p>	(0.9) 1.0 1.2		DB, ÜZ, ÖBB, GL, UDT, SEPROZ	<p>Copper coated GMAW wire for high strength, quenched and tempered fine-grained constructional steels.</p> <p>The wire is suited for joint welding in boiler, pressure vessel, pipeline, and crane construction as well as in structural steel engineering. The typical composition of the wire fulfils the requirements of the NORSOK regulation for „water injection systems“.</p> <p>Due to the precise addition of micro alloying elements NiMo 1-IG wire features excellent ductility and crack resistance in spite of its high strength. Good cryogenic impact energy down to -60 °C, low hydrogen contents in the deposit, best feedability and low copper contents are other advantages of this wire.</p>	<p>Pipe steels and fine grained steels, quenched and tempered fine-grained steels.</p> <p>S380N-S500N, S380NL-S500NL, S500NC-S550NC, N-A-XTRA 56-70, BHV 70, PAS 600, HSM 600, 20MnMoNi5-5</p> <p>ASTM: A517 Gr.A,B,C,E,F, H,J,K,M,P; A225 Gr.C, A633 Gr.E, A572 Gr.65</p> <p>API Spec. 5 L: X70, X80</p>

Other consumables for pipeline welding

BÖHLER AWS EN	Welding process	Typical analysis	Typical mechanical properties	Sizes	Amperage	Approvals	Characteristics and applications
		%	N/mm ² (KSI)	mm	A		
FOX CEL S E6010	GMAW	C 0.10 Si 0.20 Mn 0.50	Re 480 (70) Rm 550 (80) A5 23 % Av 110 J	2.5 3.2 4.0	–	–	Cellulosic electrode especially designed for vertical up welding of root passes on D.C. positive polarity. Can be used however, also vertical down and on negative polarity. Ideally suited for the "Dolly Mix" technique. It shows a forceful arc and good operating characteristics.
FOX CEL 75 G E7010-G	GMAW	C 0.14 Si 0.10 Mn 0.7 Ni 0.6	Re 460 (68) Rm 550 (80) A5 24 % Av 110 J -40°C: 65 J	3.2 4.0 5.0	–	–	Böhler FOX CEL 75 G is an AWS E7010-G cellulose coated electrode for welding the pipe grades X 56, X 60 and X 65 or the EN steels L385M, L415MB and L450MB. The electrode provides consistently high quality as well as outstanding low temperature toughness values together with superior operating characteristics.
FOX CEL 85 G E8010-G	GMAW	C 0.16 Si 0.4 Mn 0.7 Ni 0.7	Re 490 (71) Rm 570 (82) A5 23 % Av 105 J -40°C: 70 J	3.2 4.0 5.0	–	–	Böhler FOX CEL 85 G is an AWS E8010-G cellulosic electrode for welding the pipe grades X 60 through X 70 or the EN steels, L415MB, L450MB and L485MB. The electrode provides consistently high quality as well as outstanding low temperature toughness values together with superior operating characteristics.
FOX EV 50-W E7016-1 H4 R E 42 5 B 12 H5	SMAW	C 0.07 Si 0.5 Mn 1.1	Re 460 (67) Rm 560 (81) A5 28 % Av 200 J	2.5 3.2 4.0	40-60 55-85 80-140 110-180 180-230	TÜV-D, CL, FI, GL, UDT, LTSS, PDO, SEPROZ	Low hydrogen electrode for compressor station or pressure reduction construction. Excellent for root passes in the vertical up position. It has a very stable penetration arc and gives good "X"-ray quality welds. Best root welding characteristics on D.C. negative polarity. HD < 5 ml/100 g.
FOX CN 22/9 N E2209-17 E 22 9 3 N L R 3 2	SMAW	C ≤0.03 Si 0.9 Mn 0.8 Cr 23.0 Ni 9.0 Mo 3.2 N 0.17 PREN ≥35	Re 650 (94) Rm 820 (118) A5 25 % Av 55 J -20°C ≥ 32 J	2.5 3.2 4.0 5.0	40-75 70-120 110-150 110-180 150-200	TÜV-D, TÜV-A, ABS, CL, DNV, GL, LR, RINA, Statoil, UDT, SEPROZ	Rutile basic coated alloyed-core wire electrode for the welding of ferritic-austenitic duplex steels e.g. 1.4462, UNS 31803. Highly recommended for vertical up welding of tubes and pipes (electrode diameter 2,5 mm; D.C., electrode negative). Good weldability on A.C.
FOX CN 22/9 N-B E2209-15 E 22 9 3 N L B 2 2	SMAW	C ≤0.03 Si 0.3 Mn 1.1 Cr 23.0 Ni 8.8 Mo 3.2 N 0.16 PREN ≥35	Re 630 (92) Rm 830 (121) A5 27 % Av 105 J -60°C 40 J	2.5 3.2 4.0 5.0	50-75 80-110 100-145 140-180	TÜV-D, UDT, CL	Basic coated DUPLEX electrode for UNS S31803. The weld deposit shows excellent impact properties down to -60 °C and assures safe welding of heavy wall thicknesses under high requirements. The "Pitting Resistance Equivalent" is ≥ 35 (PREN = % Cr + 3,3 x % Mo + 16 x % N) the ferrite content of the weld deposit is ≥ 30 FN.
CN 22/9 N-IG ER2209 W 22 9 3 N L G 22 9 3 N L	GTAW GMAW	C ≤ 0.015 Si 0.4 Mn 1.7 Cr 22.6 Mo 3.2 Ni 8.8 N 0.15 PREN ≥35	GTAW: Re 600 (87) N/mm ² Rm 800 (116) N/mm ² A5 33 % Av 150 J -60°C ≥ 32 J GMAW: Re 660 (95) N/mm ² Rm 830 (120) N/mm ² A5 28 % Av 85 J -40°C ≥ 32 J	1.6 2.0 2.4 3.2 1.0 1.2	–	TÜV-D, TÜV-A, ABS CL, DNV, GL, LR, Statoil, UDT TÜV-D, TÜV-A, CL, DNV, GL, Statoil, UDT, SEPROZ	TIG welding rod and GMAW wire highly suitable for welding ferritic-austenitic duplex steels, e.g. 1.4462, UNS 31803. The metallurgical design of CN 22/9 N-IG with an optimum alloying composition and closest tolerance limits ensure particularly good weld metal properties & resistance to stress corrosion cracking and pitting. it is ideally suited for the high quality requirements in pipeline welding. Best results can also be obtained with our SAW wire „CN 22/9 N-UP“ and flux „BB 202“.
CN 22/9 PW-FD E2209T1-4 E2209T1-1 T 22 9 3 N L P M 1 T 22 9 3 N L P C 1	FCAW	C ≤ 0.03 Si 0.8 Mn 0.9 Cr 22.7 Mo 3.2 Ni 9.0 N 0.13 PREN ≥35	Re 600 (87) N/mm ² Rm 800 (116) N/mm ² A5 27 % Av 80 J -46°C ≥ 45 J	1.2	100-220	TÜV-D, DNV, CL, ABS, LR, UDT, GL, RINA, CWB	Flux cored wire for positional welding. Easy to operate in all weld positions with one single parameter setting using Argon mixtures or CO ₂ . Powerful penetrating arc, spray transfer, minimum spatter formation, self releasing slag, excellent wetting behaviour, flat and smooth bead profile. Fast travel speeds and a wide range of operating parameters offer highest productivity. Suitable for service temperatures from -46 °C to 250 °C.

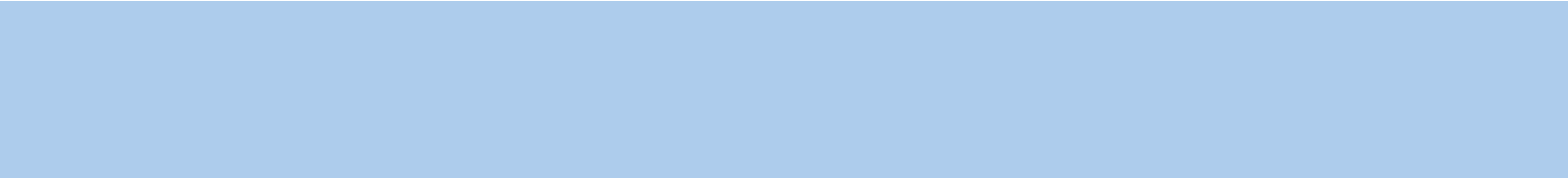

OFFLINE WELDING

Bohler
WELDING



Details regarding the nature and application purposes of our products are intended for the information of the user. The data concerning the mechanical properties always refers to the all weld metal deposit in accordance with the applicable standards. In the area of the weld joint, the weld metal properties are influenced by the base metal, the welding position and the welding parameters. A guarantee of the suitability for a specific type of application requires in each individual case an implicit agreement in writing.

Subject to change without notice.

Published by BÖHLER WELDING

Böhler Schweißtechnik Austria GmbH

Böhler-Welding-St. 1

8605 Kapfenberg / AUSTRIA

☎ +43 (0) 3862-301-0

☎ +43 (0) 3862-301-95193

✉ postmaster.bsga@bsga.at

www.boehler-welding.com

Member of the BÖHLER-UDDEHOLM Group

Your partner: